

Client Project

Client: Humira

Project: SmartShare Mobile

Creator: Wunderman
Edited by: Wunderman

Date Created: 6/1/2009
Last Modified: 6/5/2009

Summary

This document includes:

- Navigational Flows

Block wireframes represent page contents only, and do not reflect layout or priority given to page elements.

0.0 Splash / Download

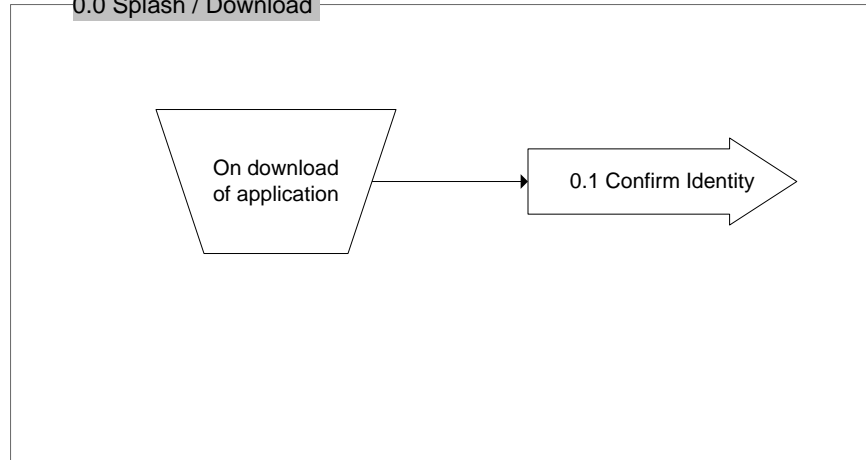

0.1 Confirm Identity

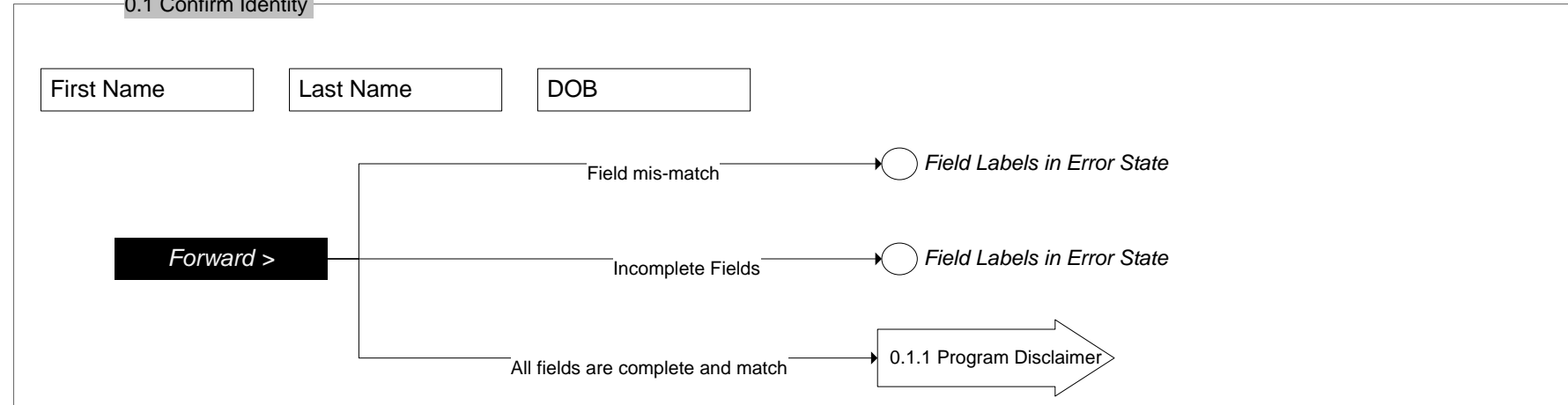

0.1.1 Program Disclaimer

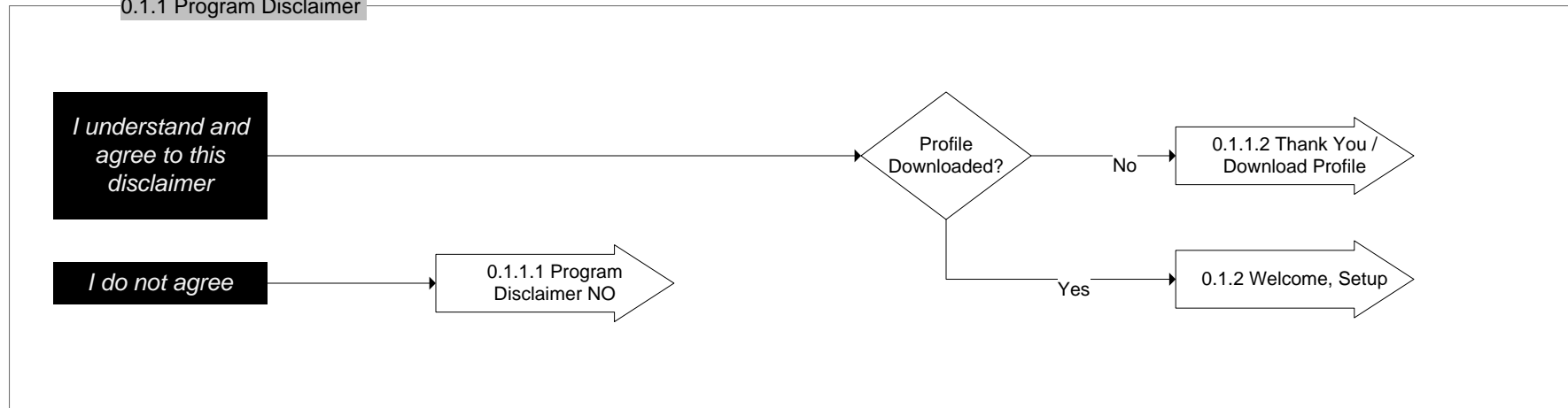

0.1.1.1 Program Disclaimer NO

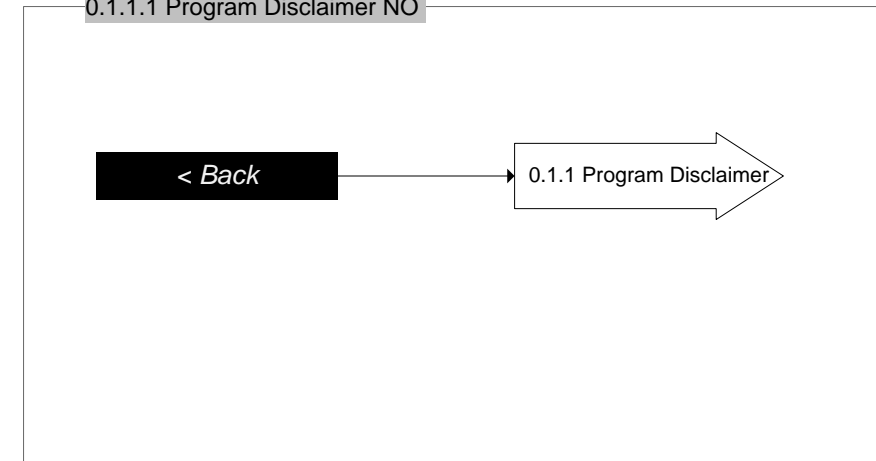

0.1.1.2 Downloading Profile

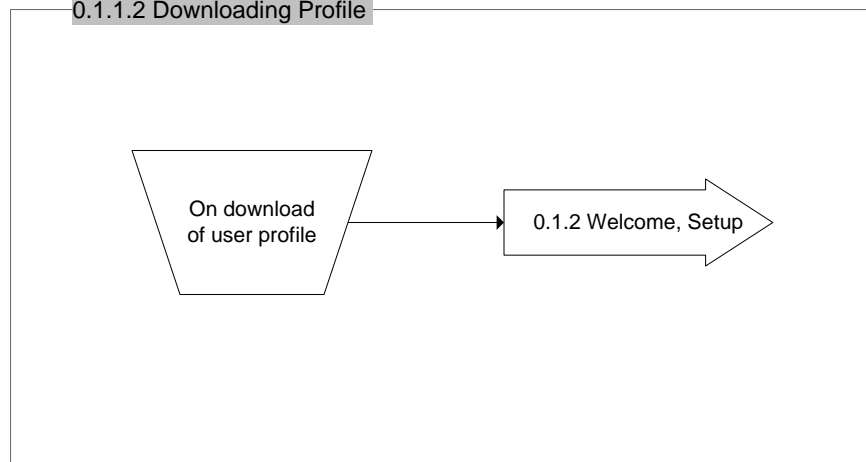

0.1.2 Welcome, Setup

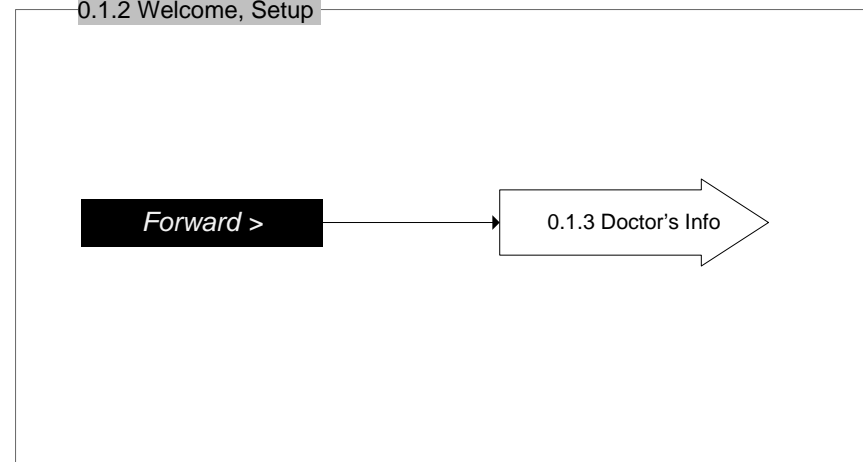

0.1.3 Doctor's Information

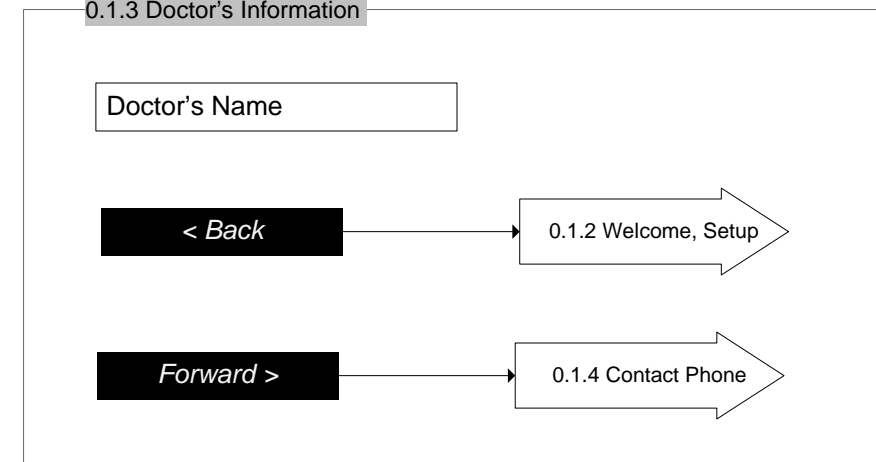

0.1.4 Contact Phone

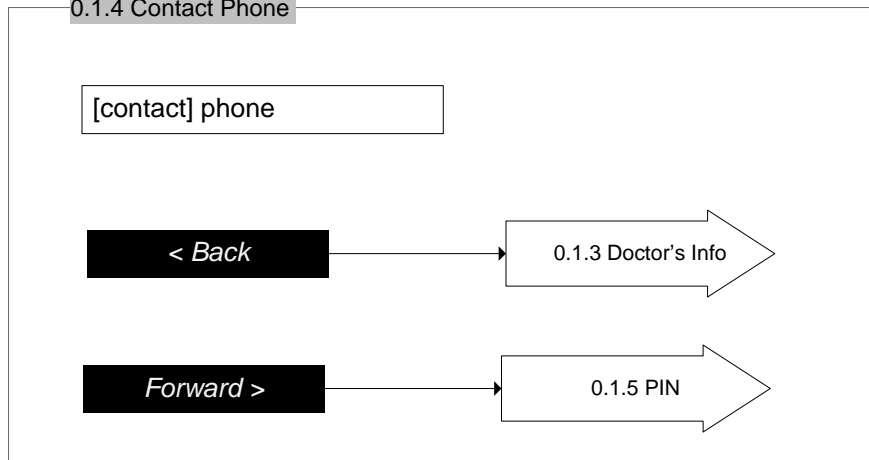

0.1.5 PIN

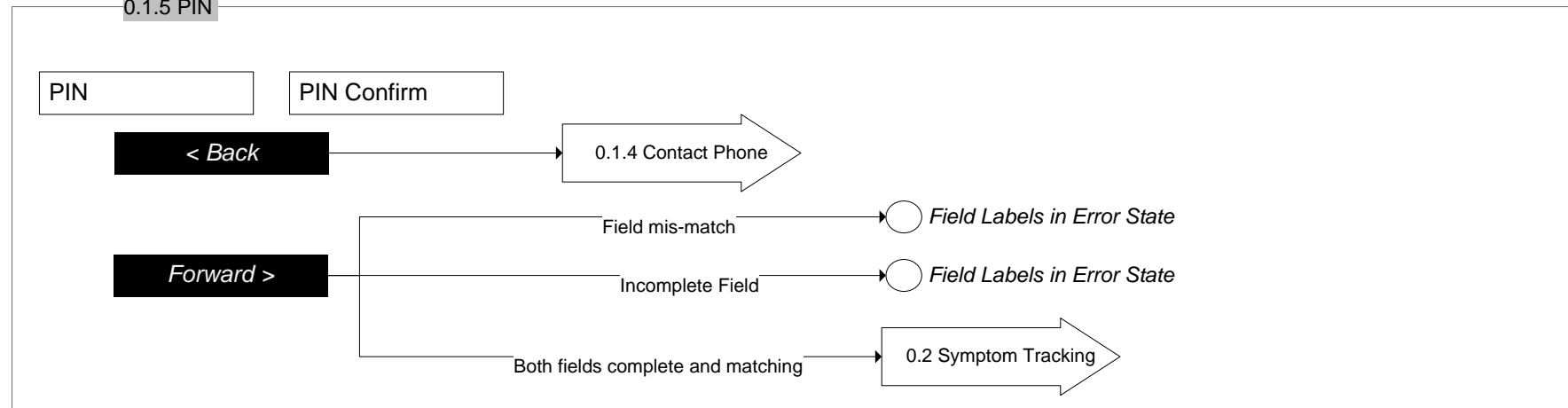

0.2 Symptom Tracking

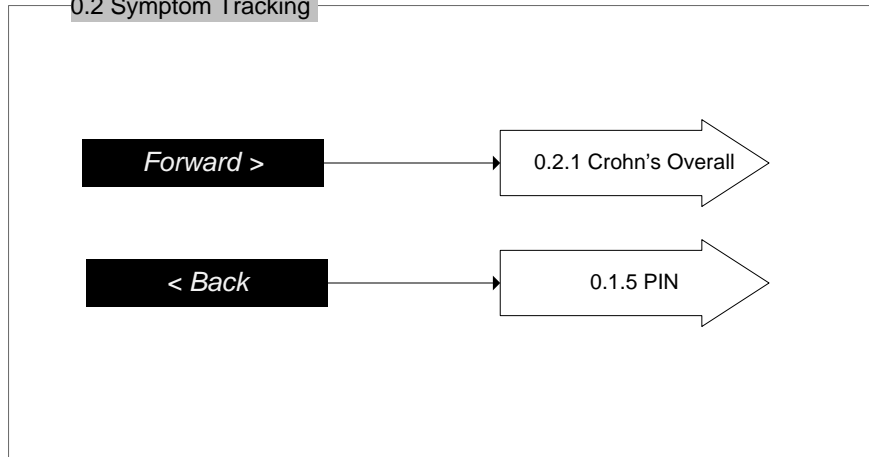

0.2.1 Crohn's Overall

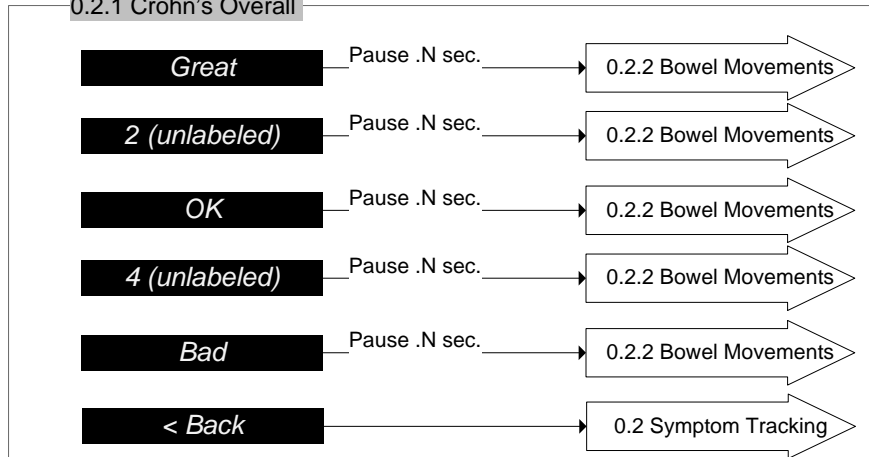

0.2.2 Bowel Movements

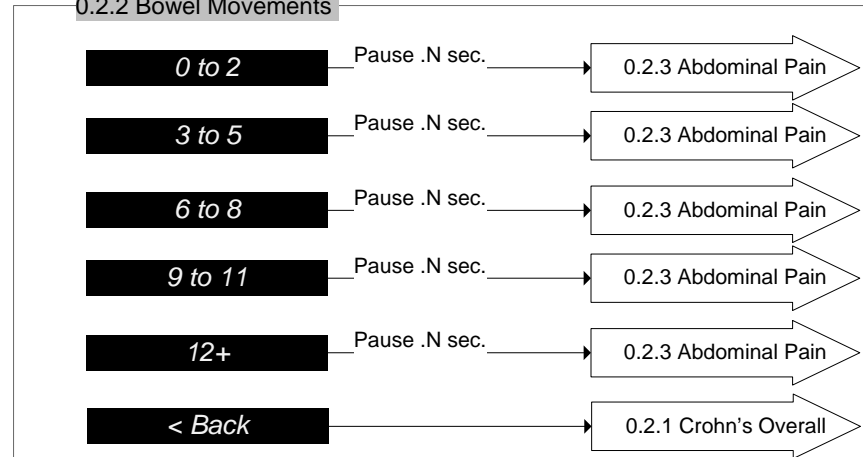

0.2.3 Abdominal Pain

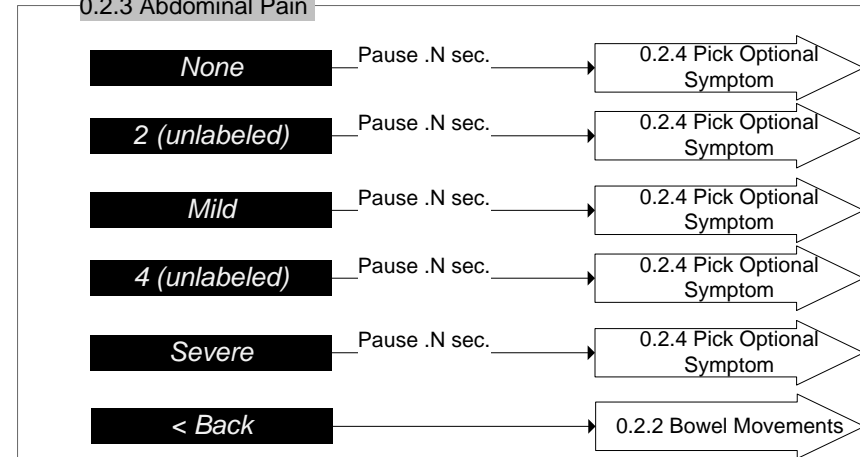

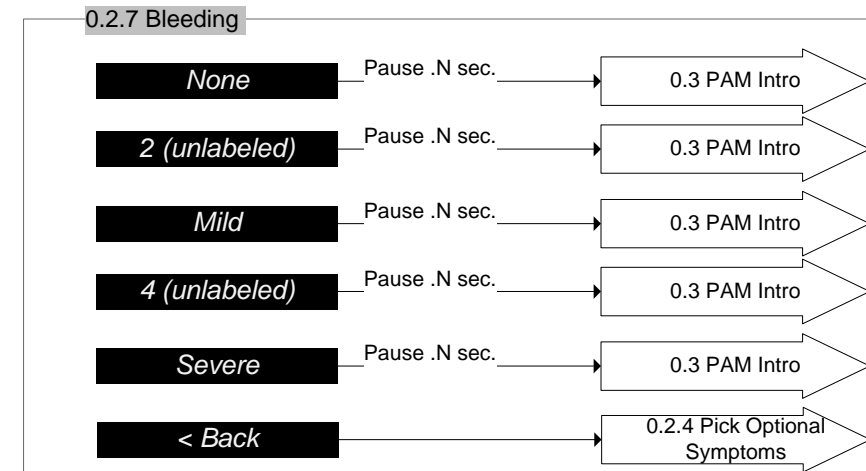
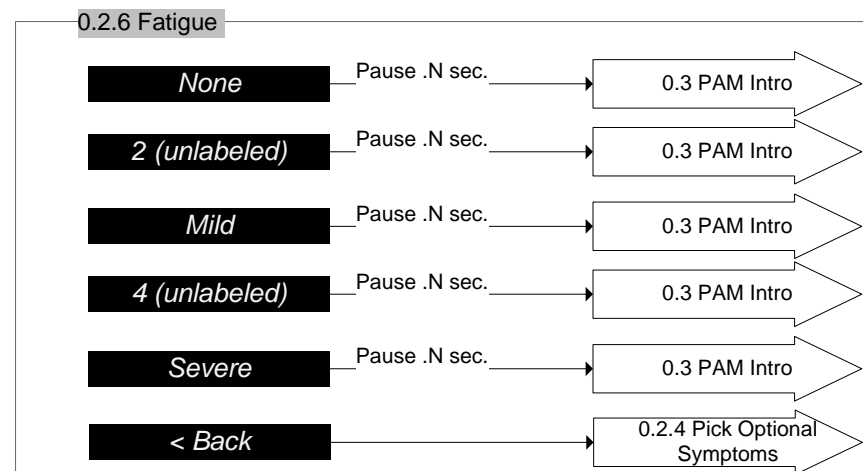
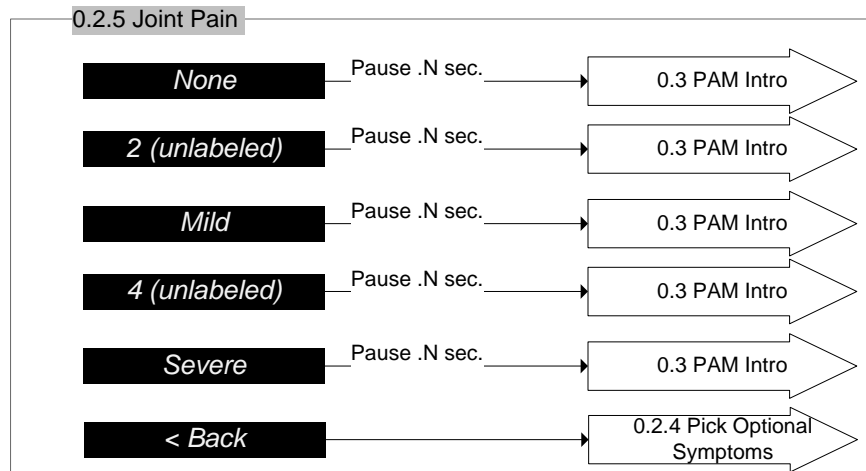
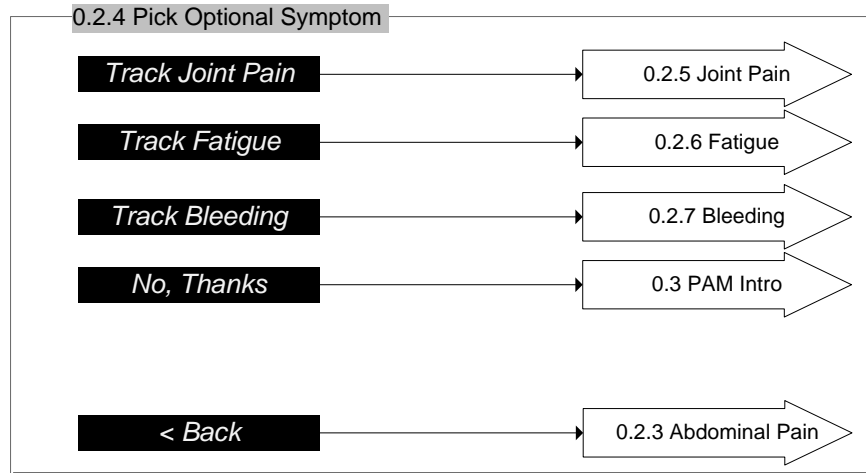

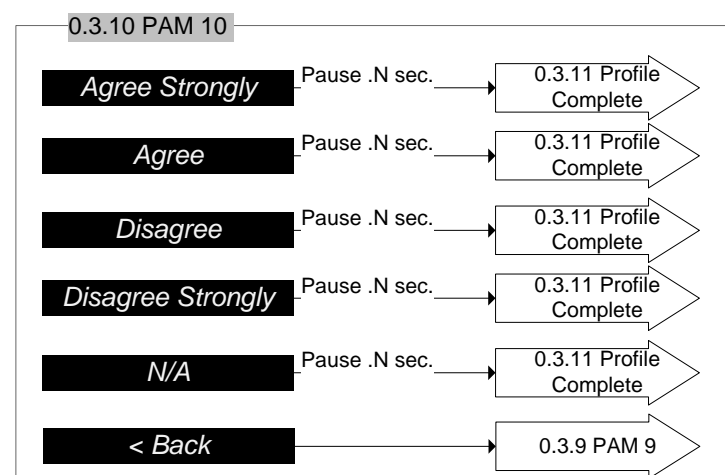
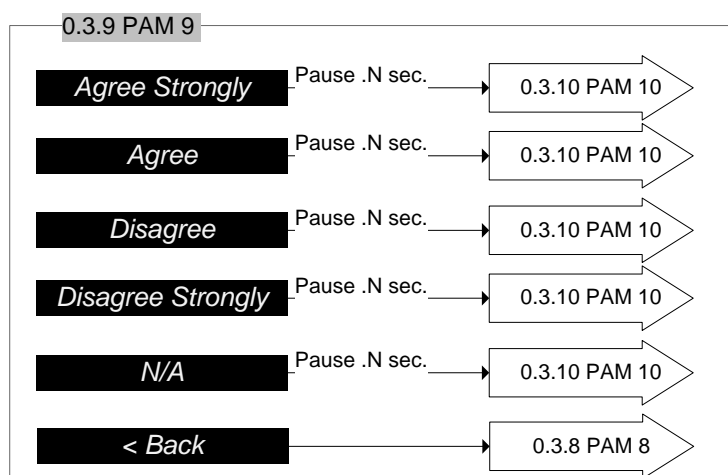
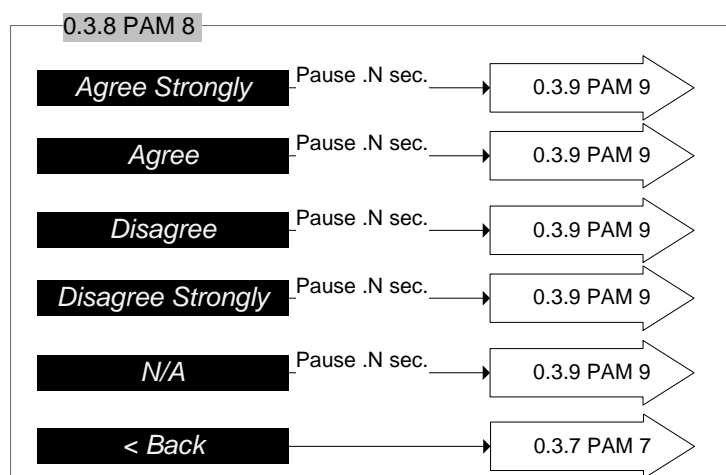
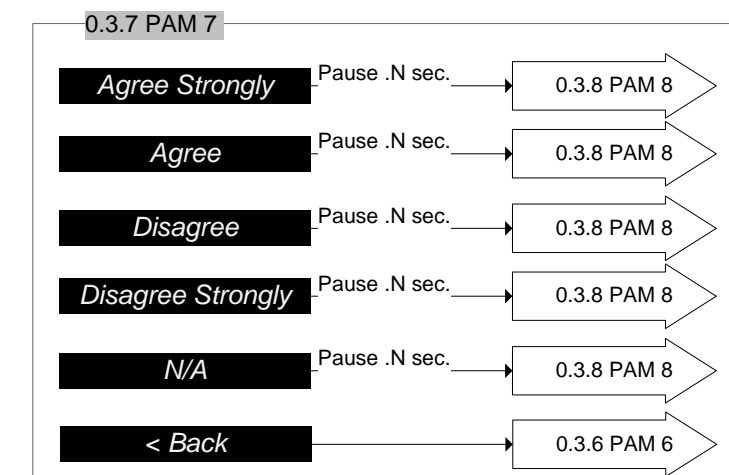
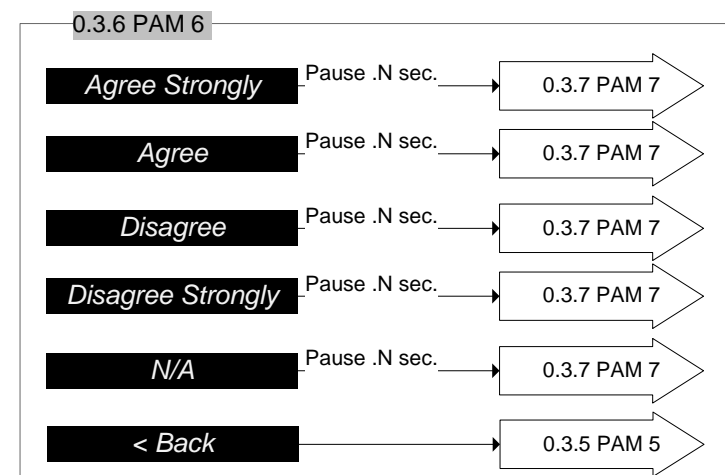
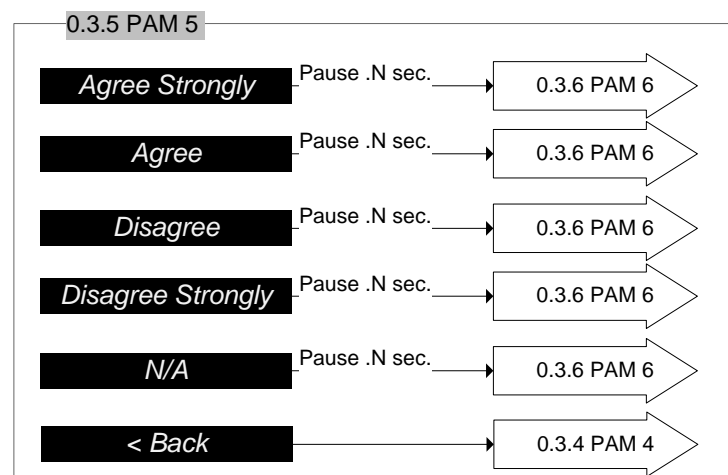
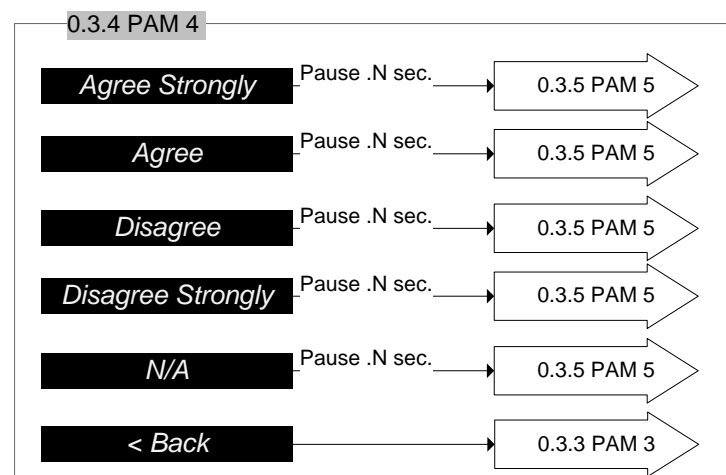
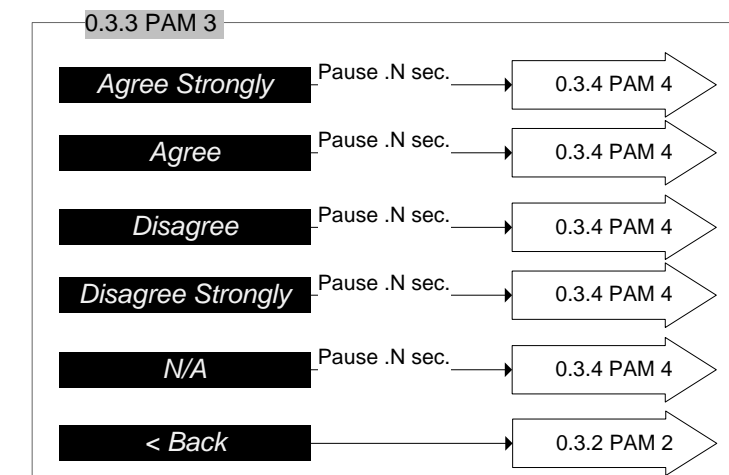
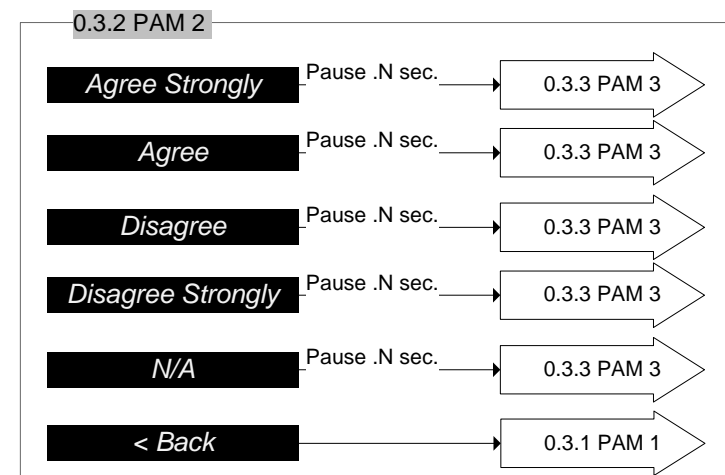
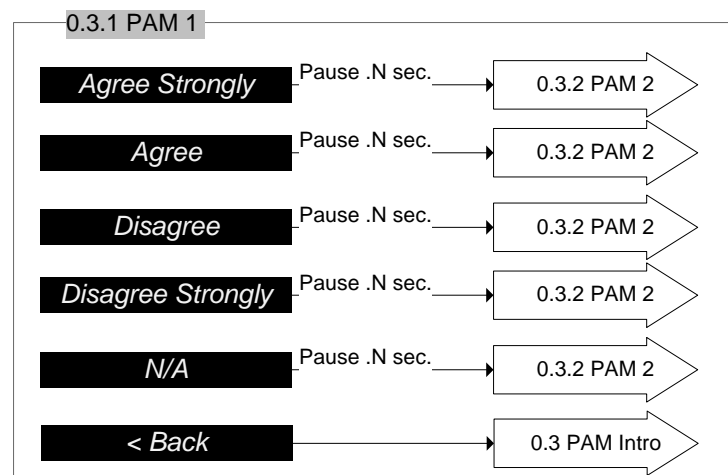
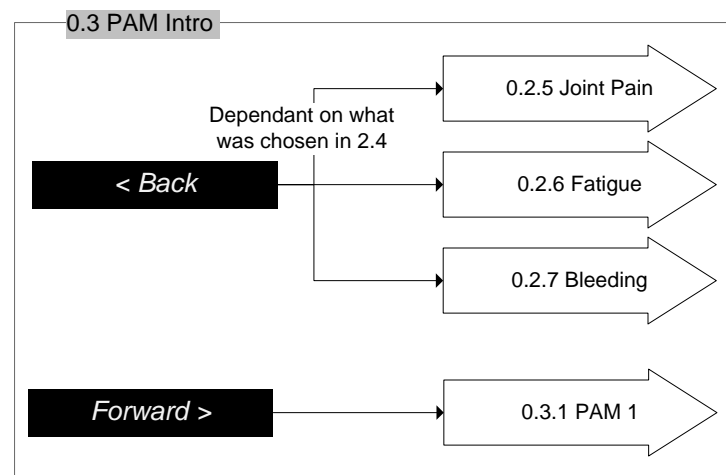

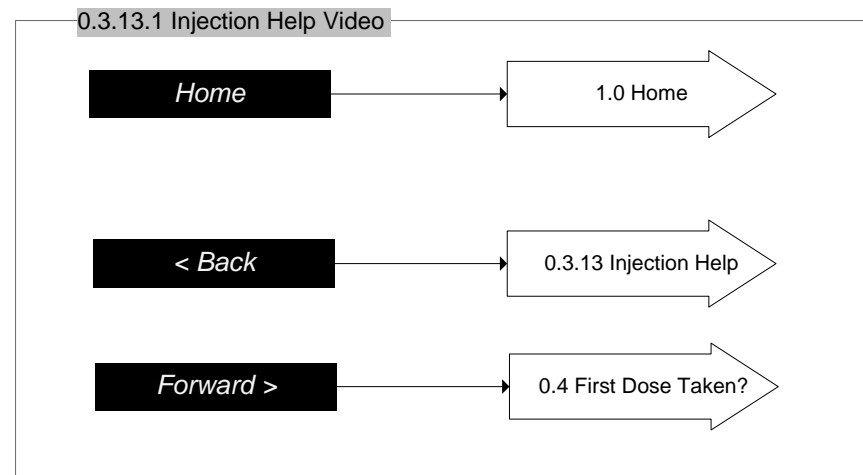
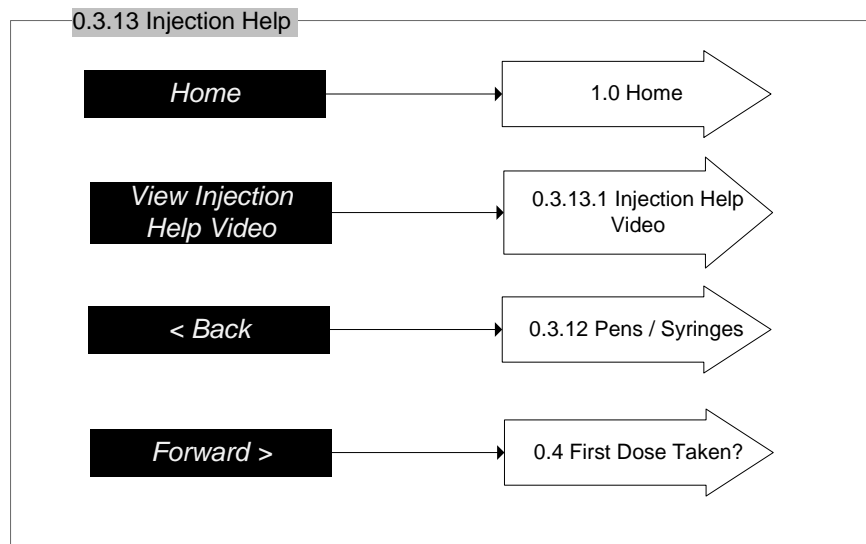
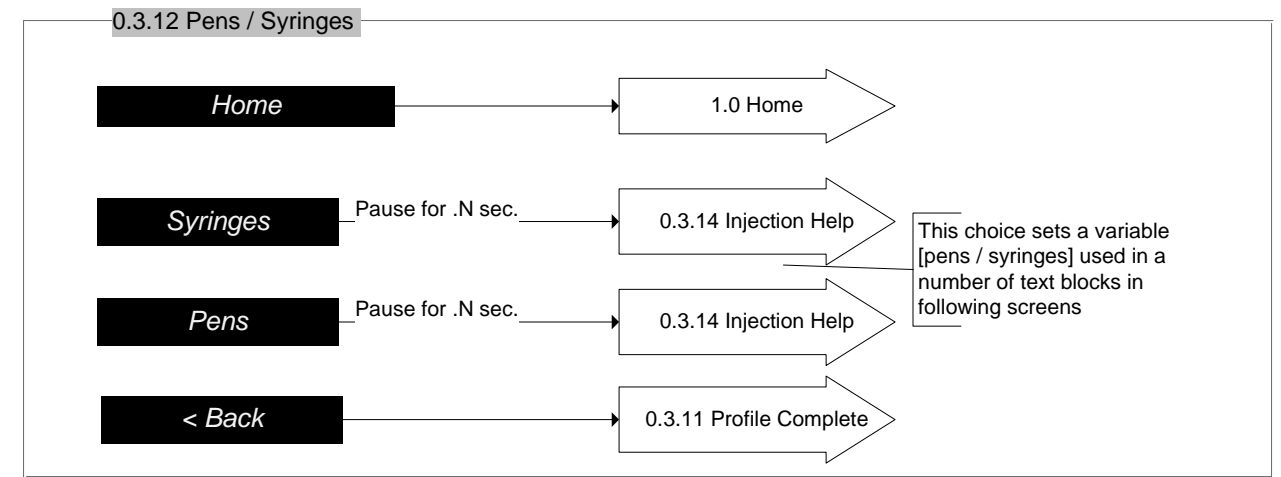
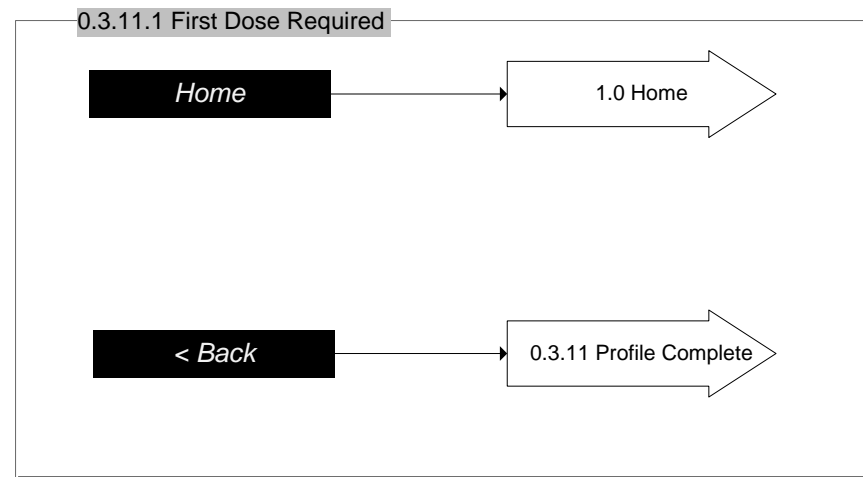
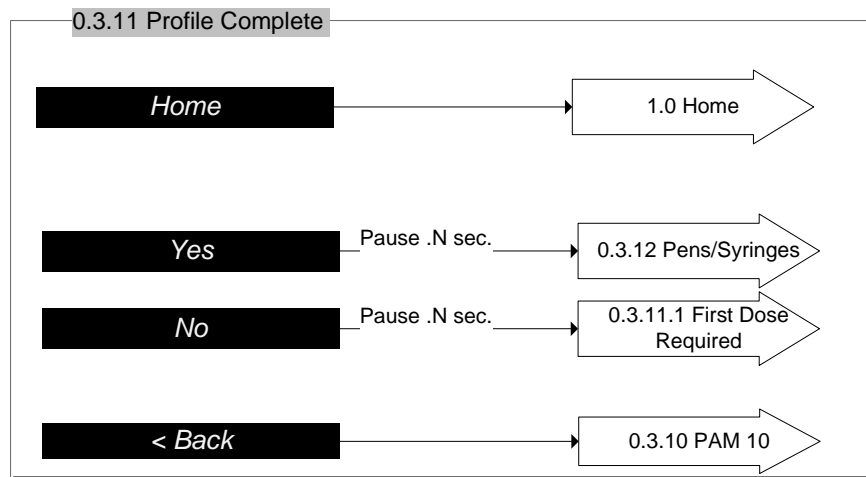

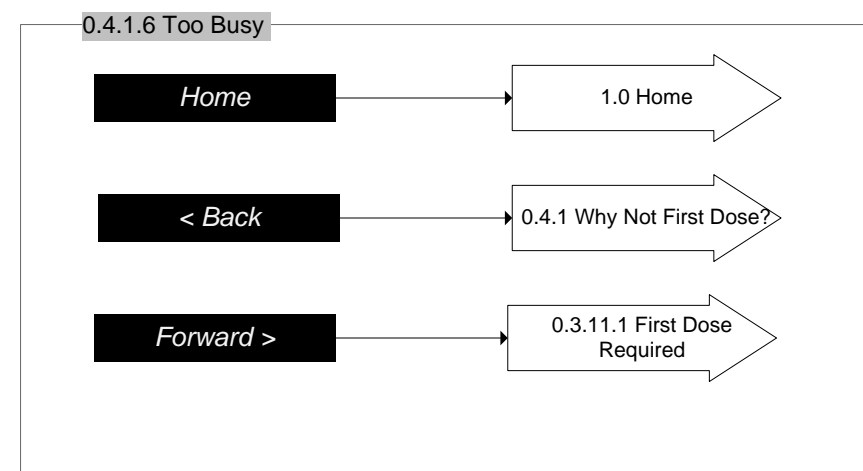
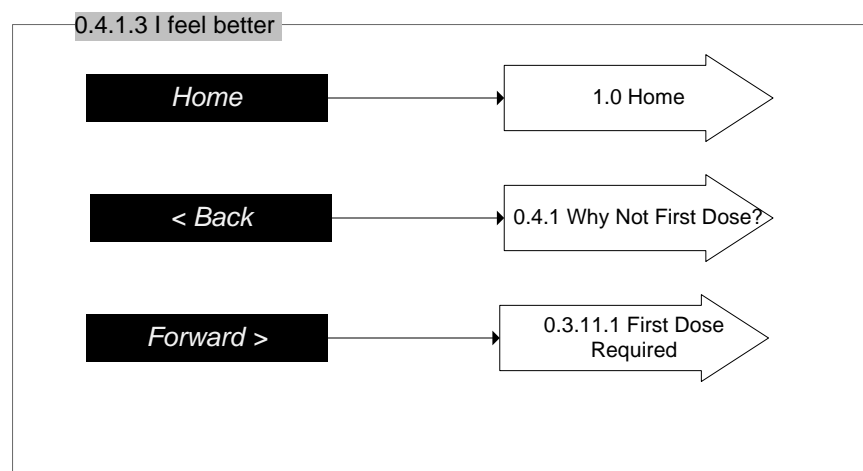
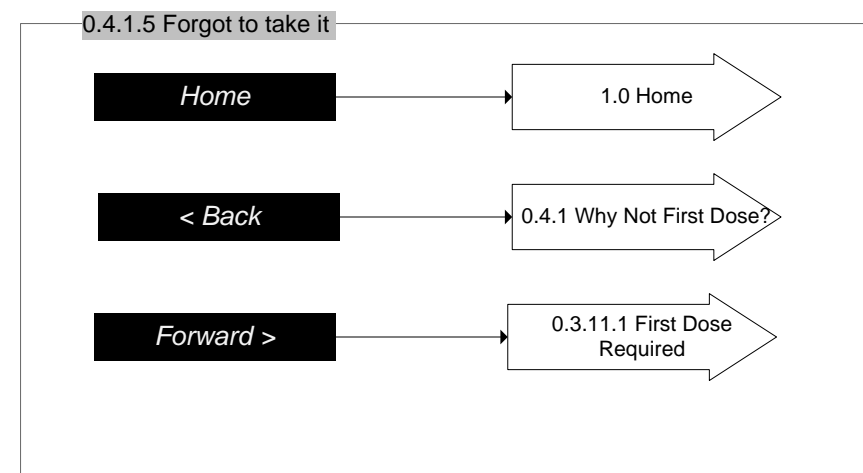
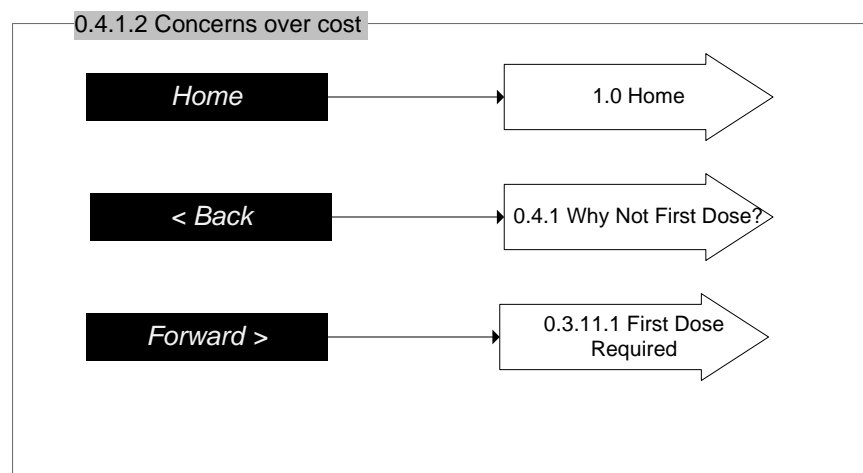
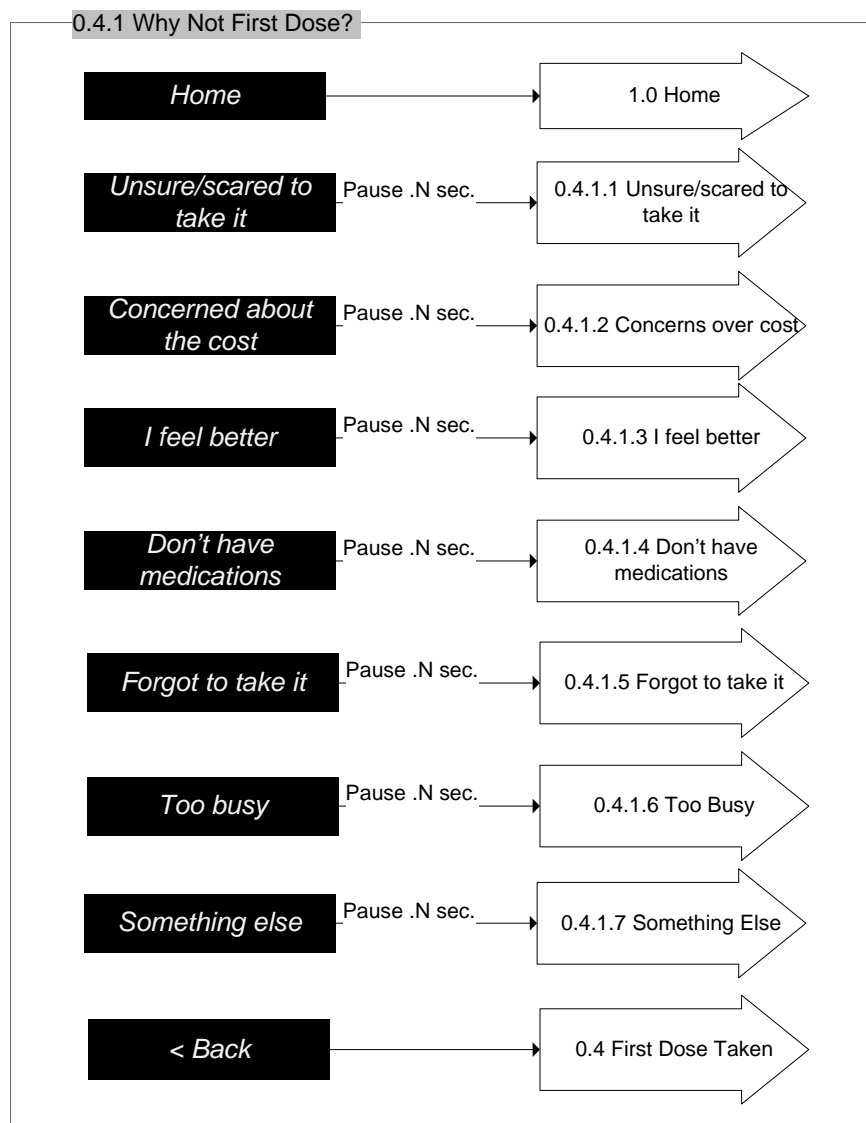
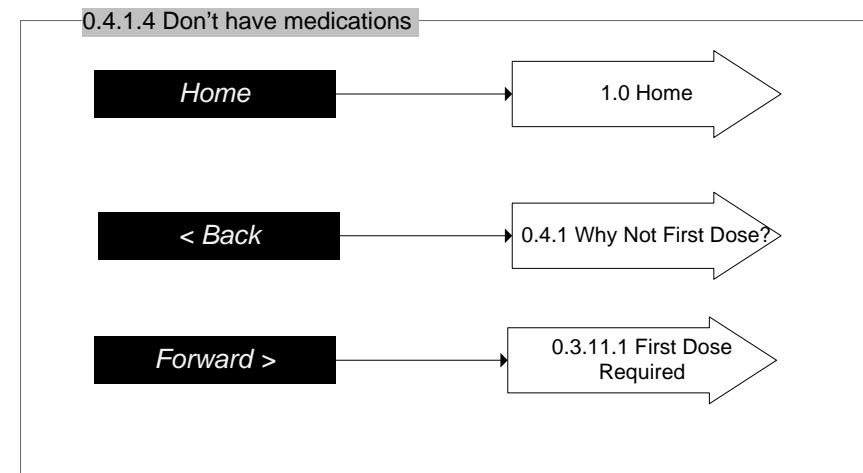
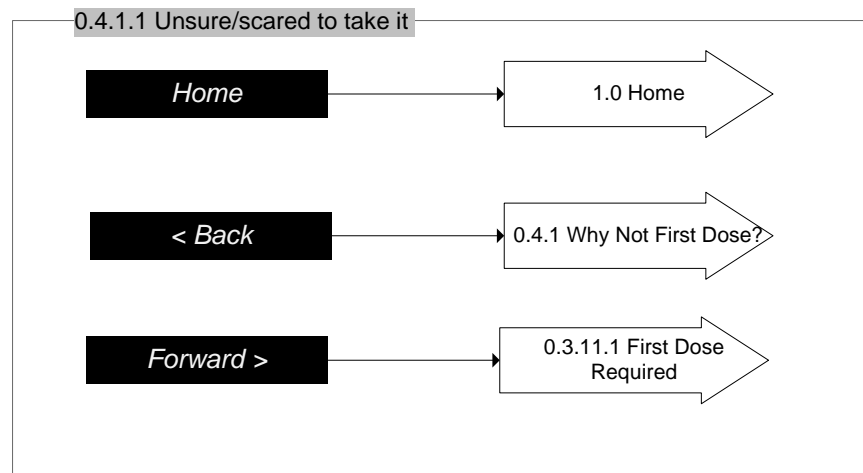
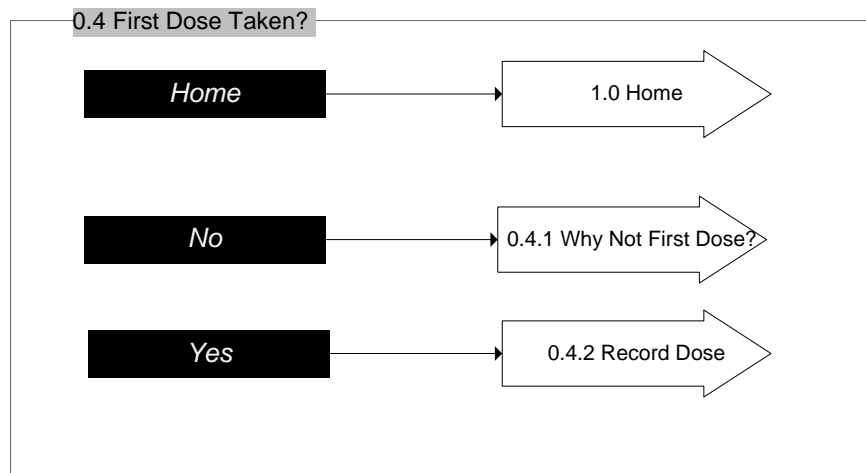

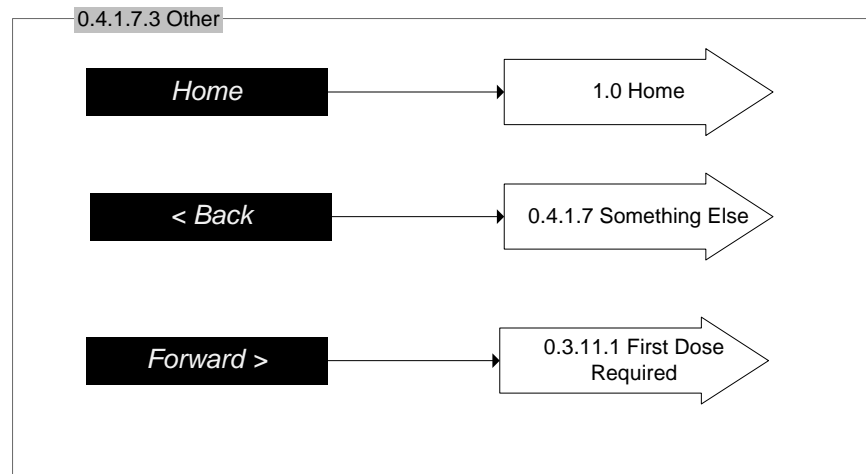
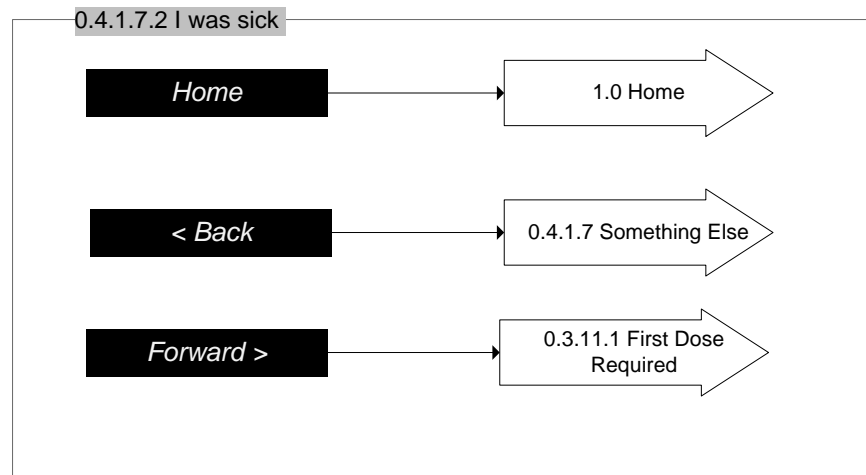
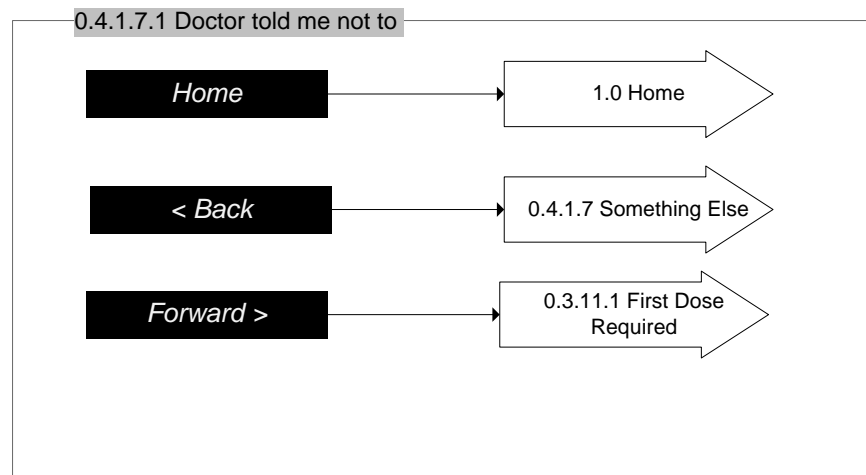
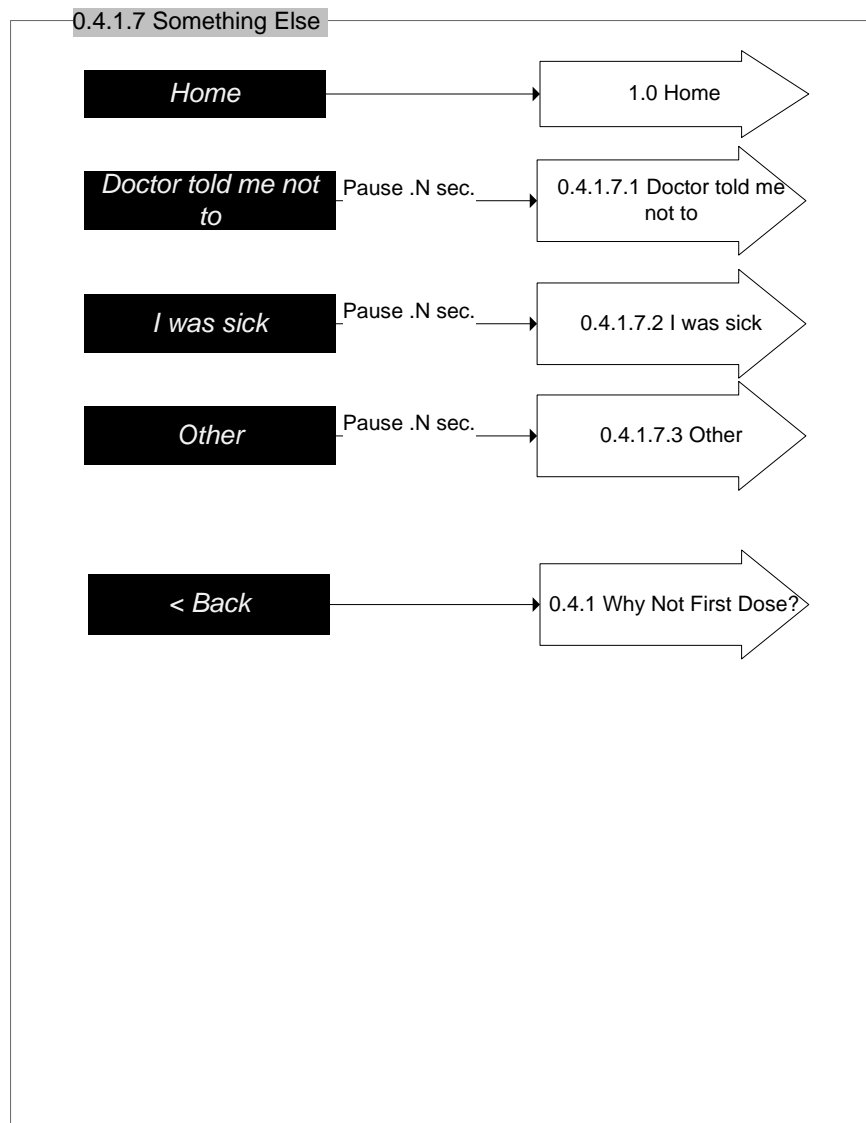

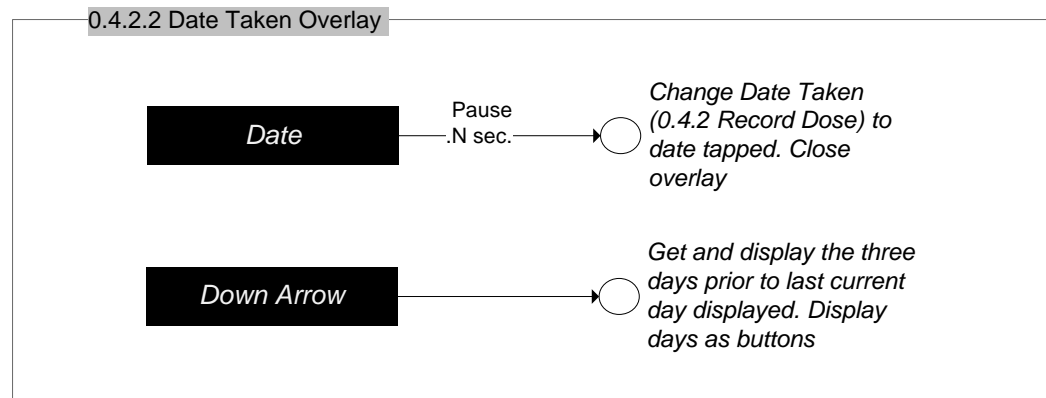
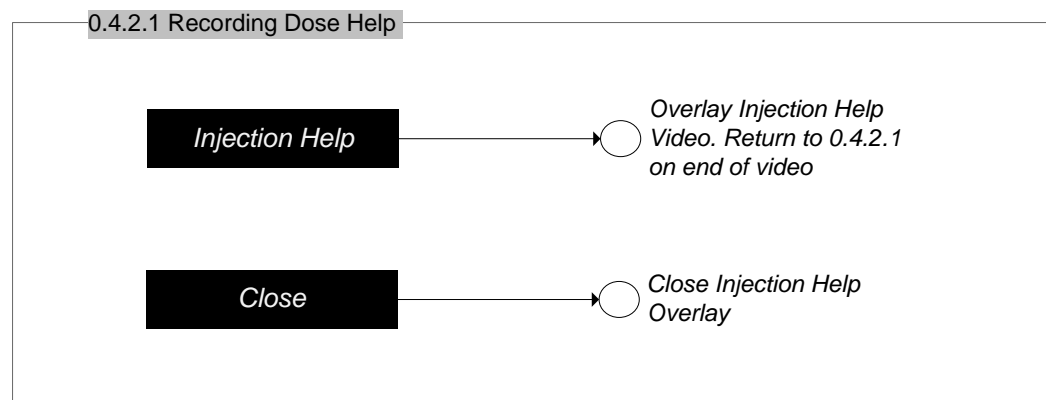
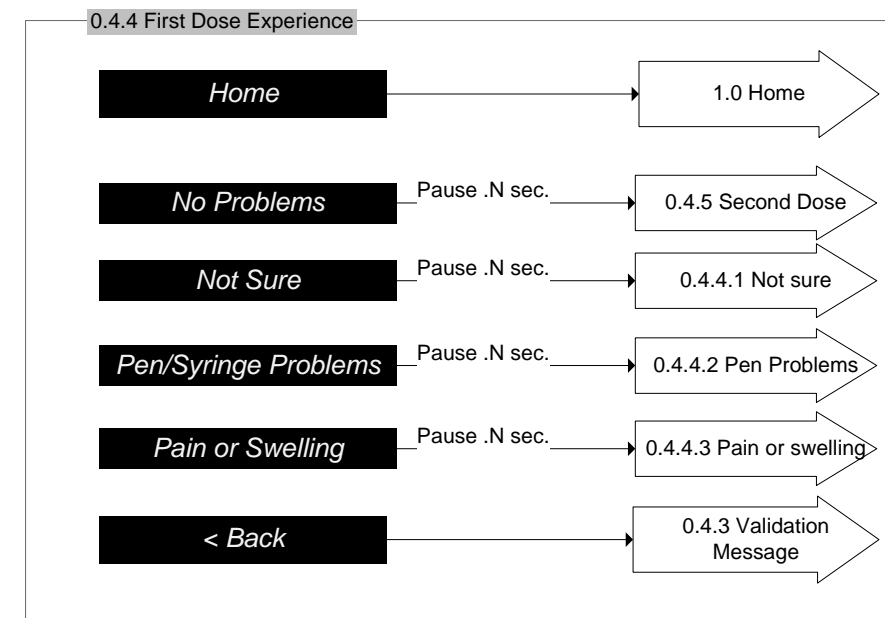
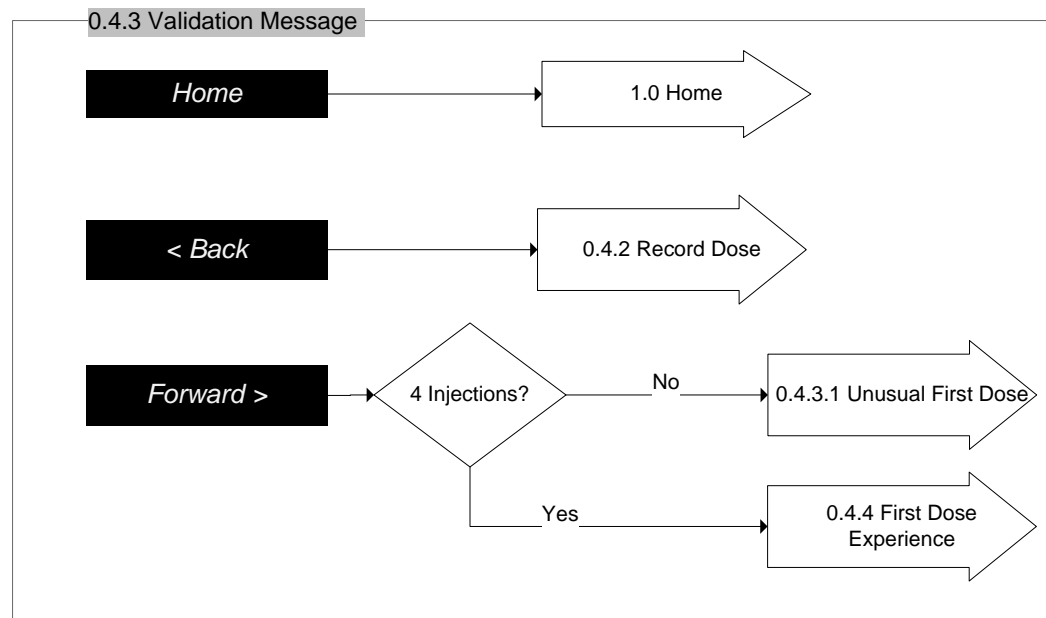
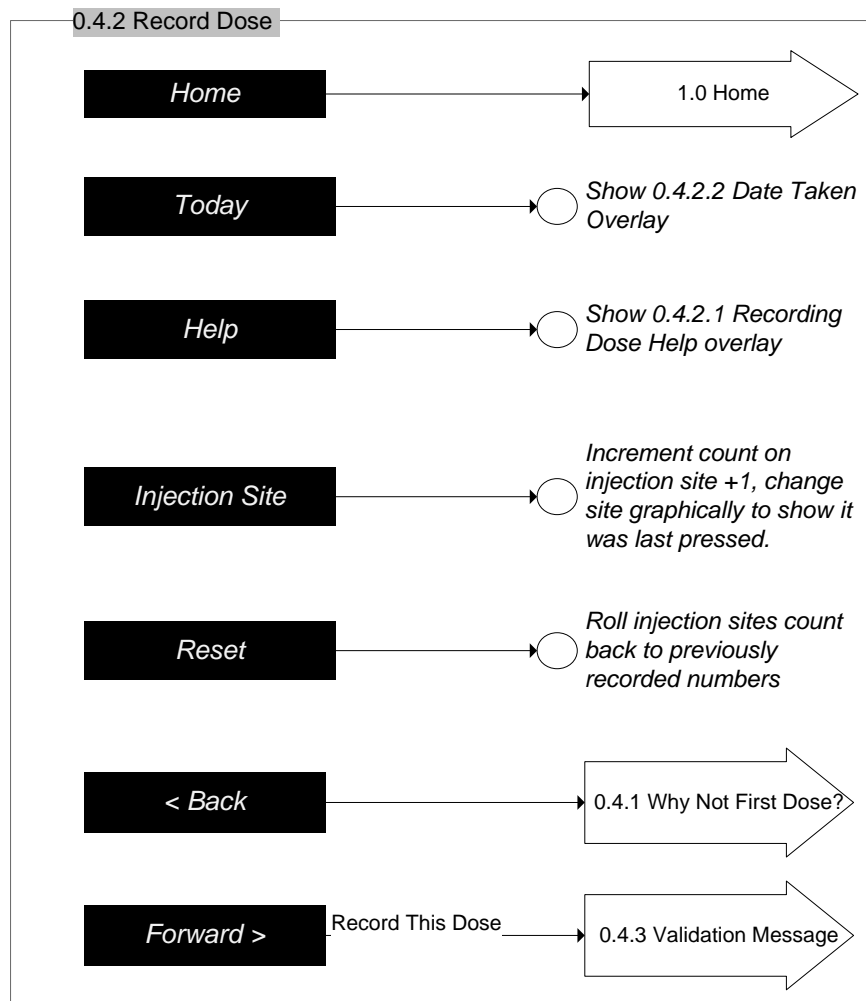

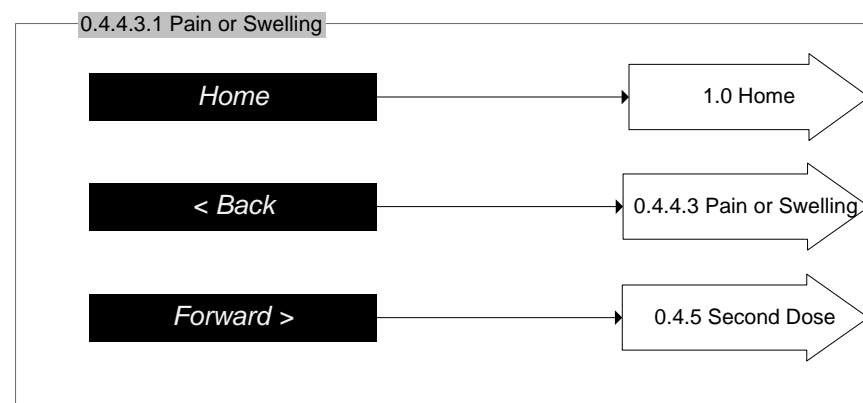
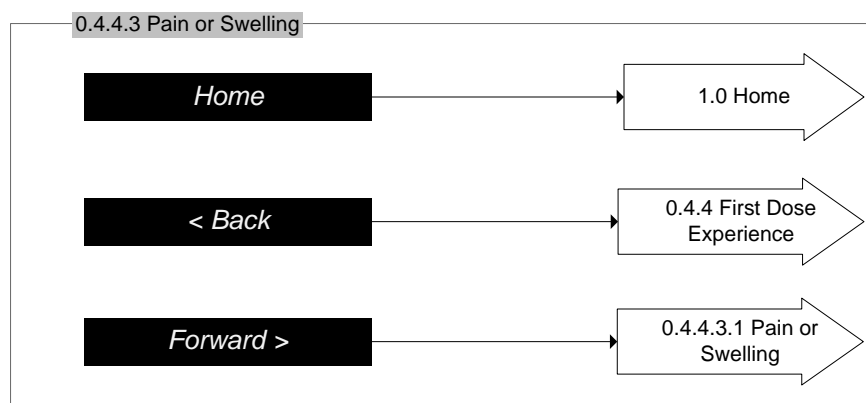
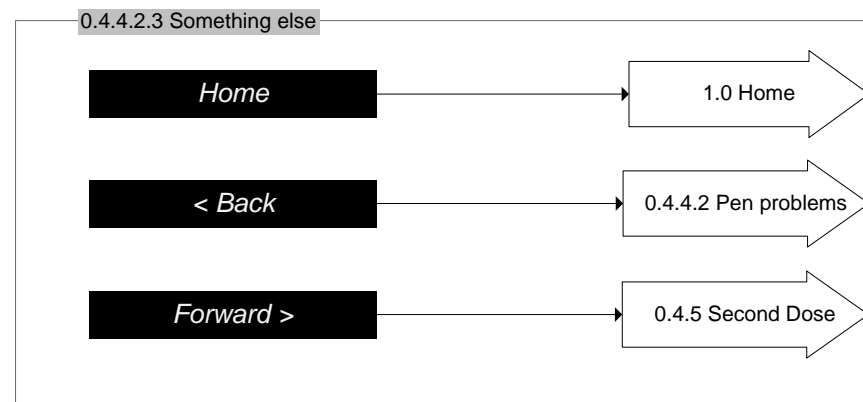
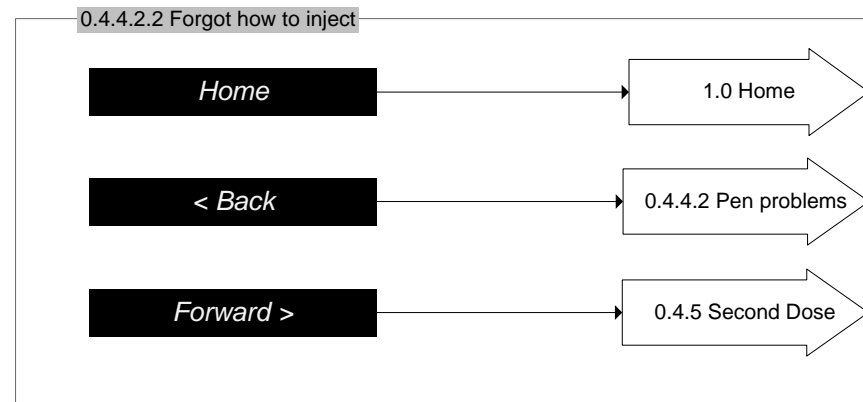
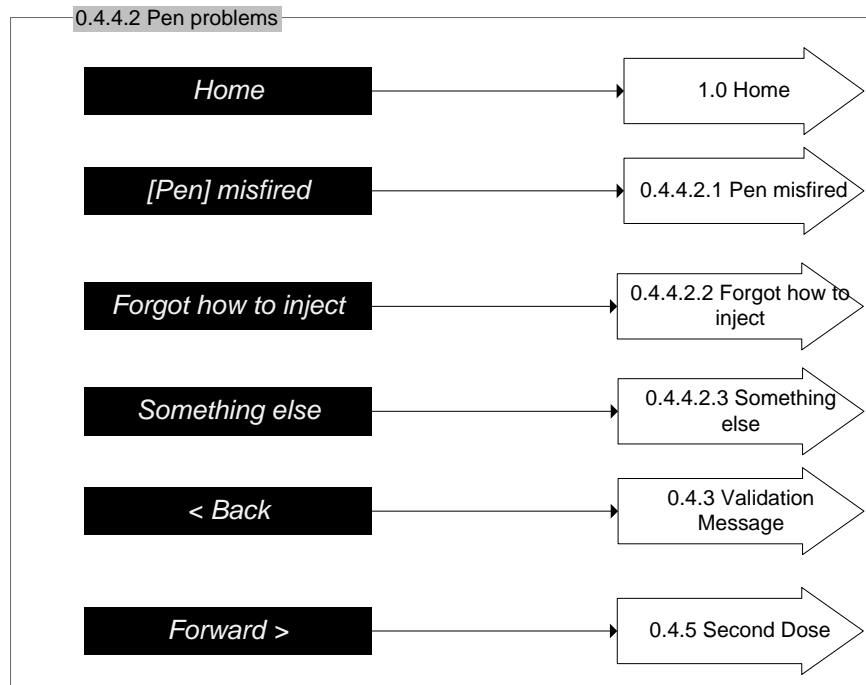
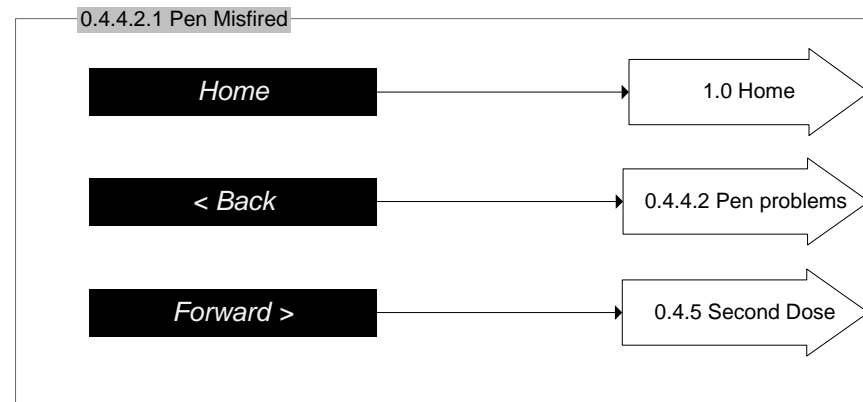
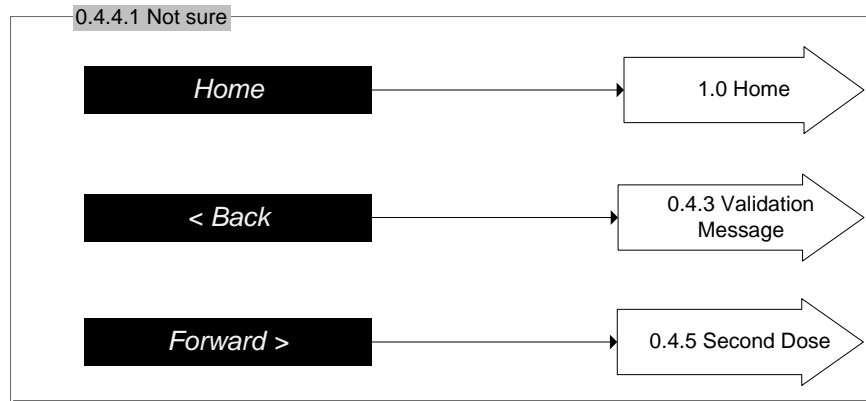

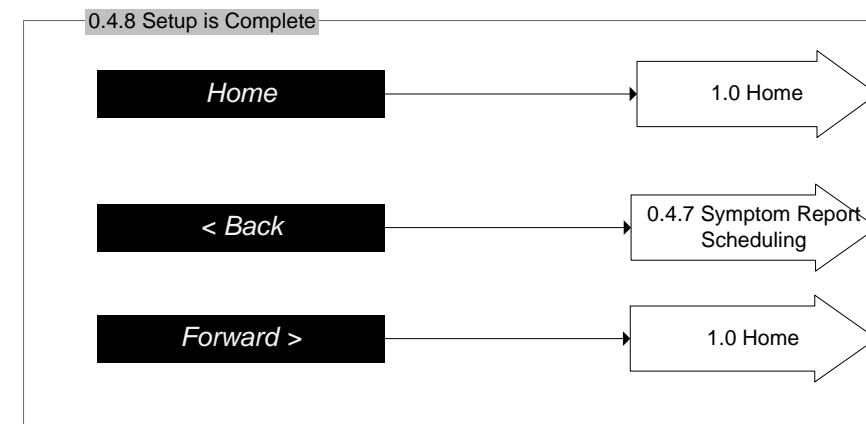
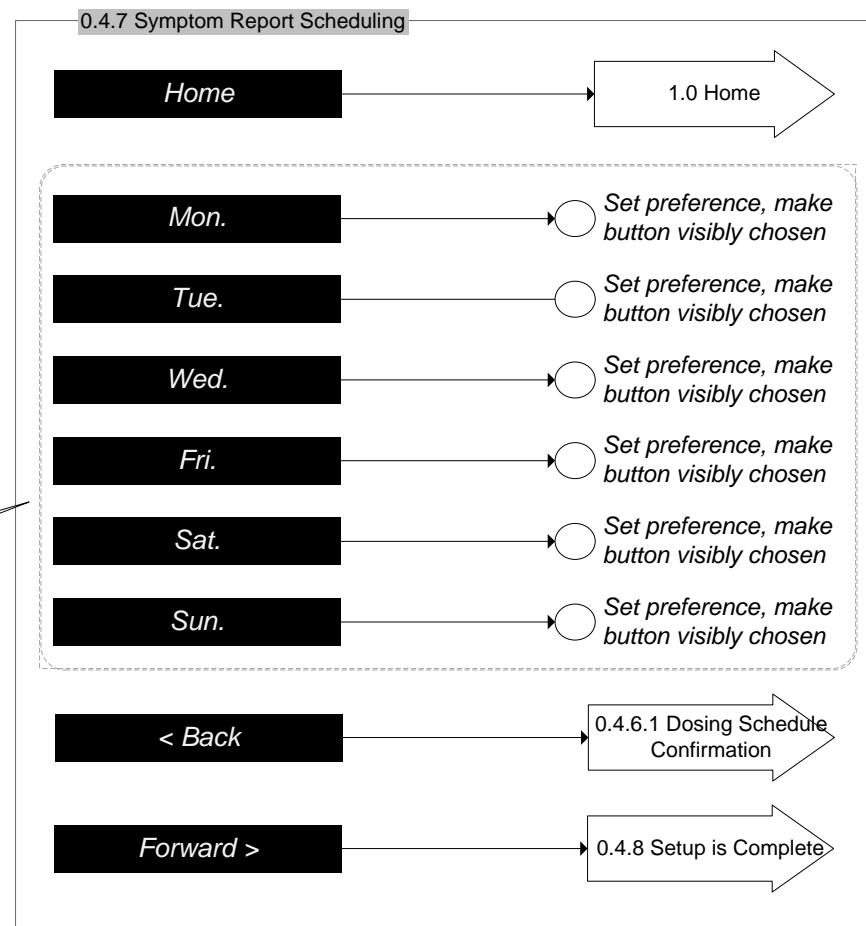
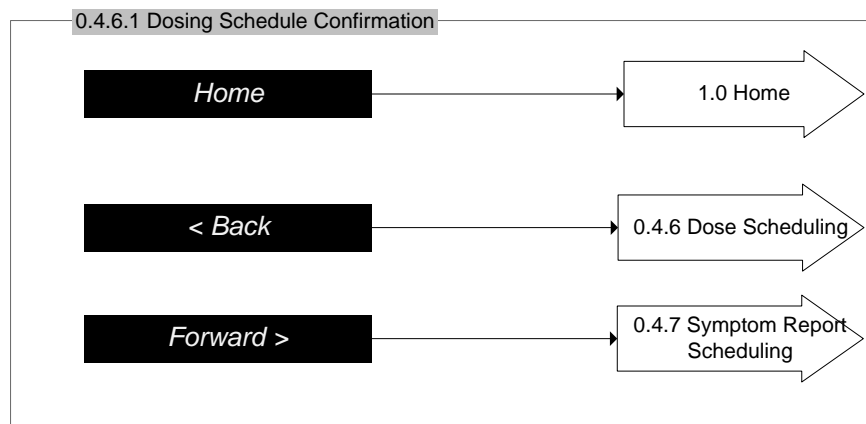
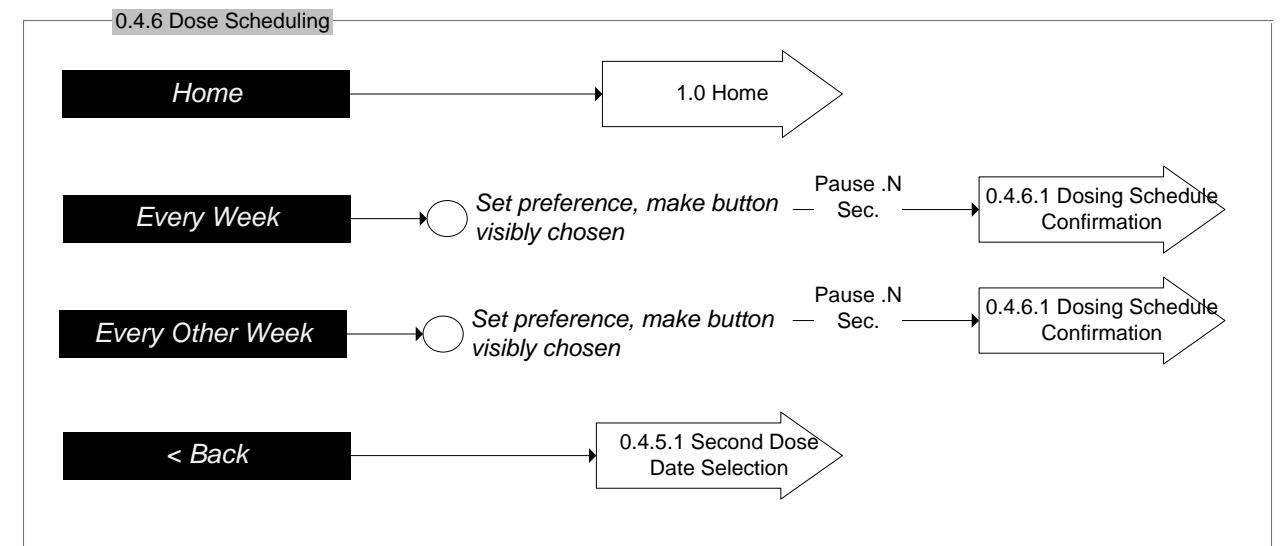
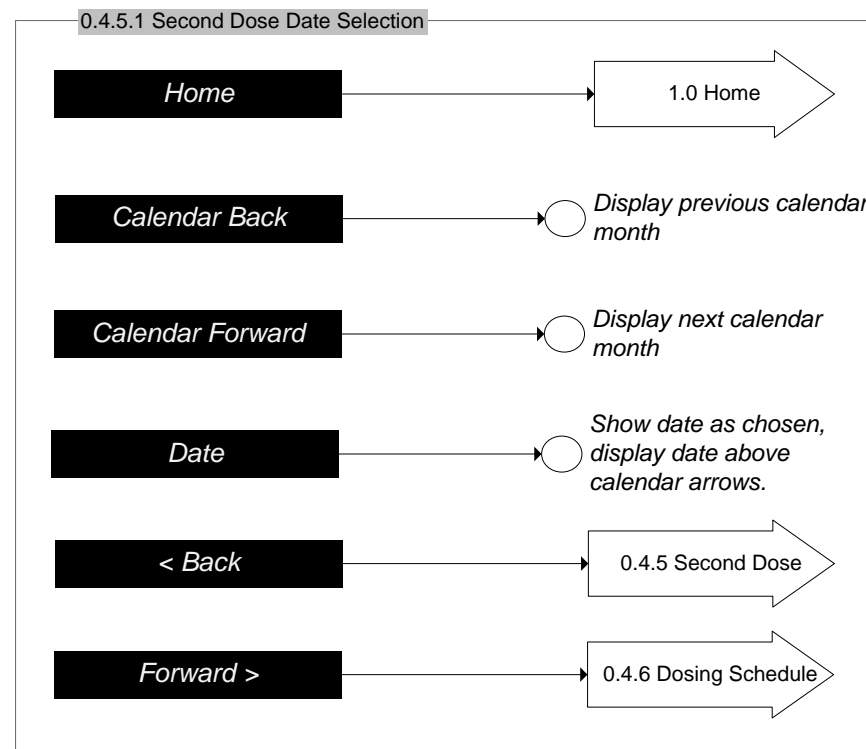
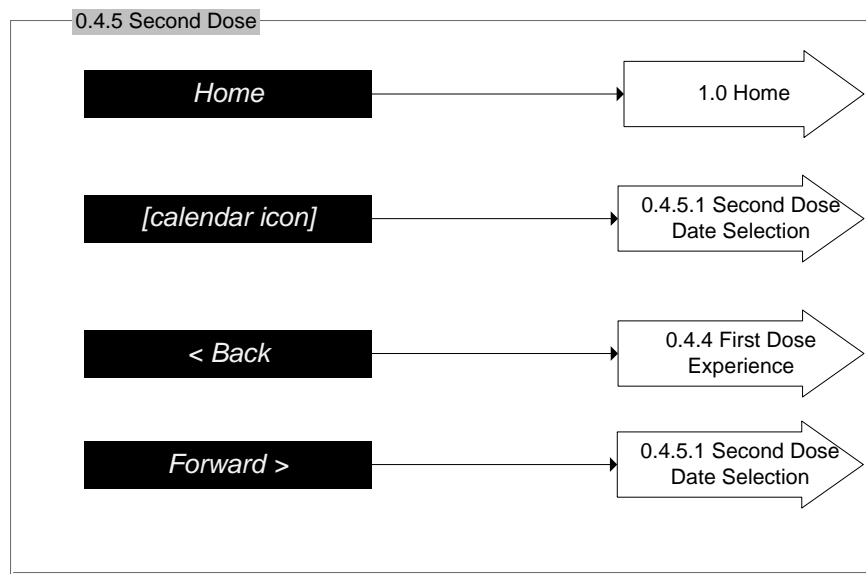

Note the 6 potential report days are the 6 days of the week NOT chosen as the dose day.

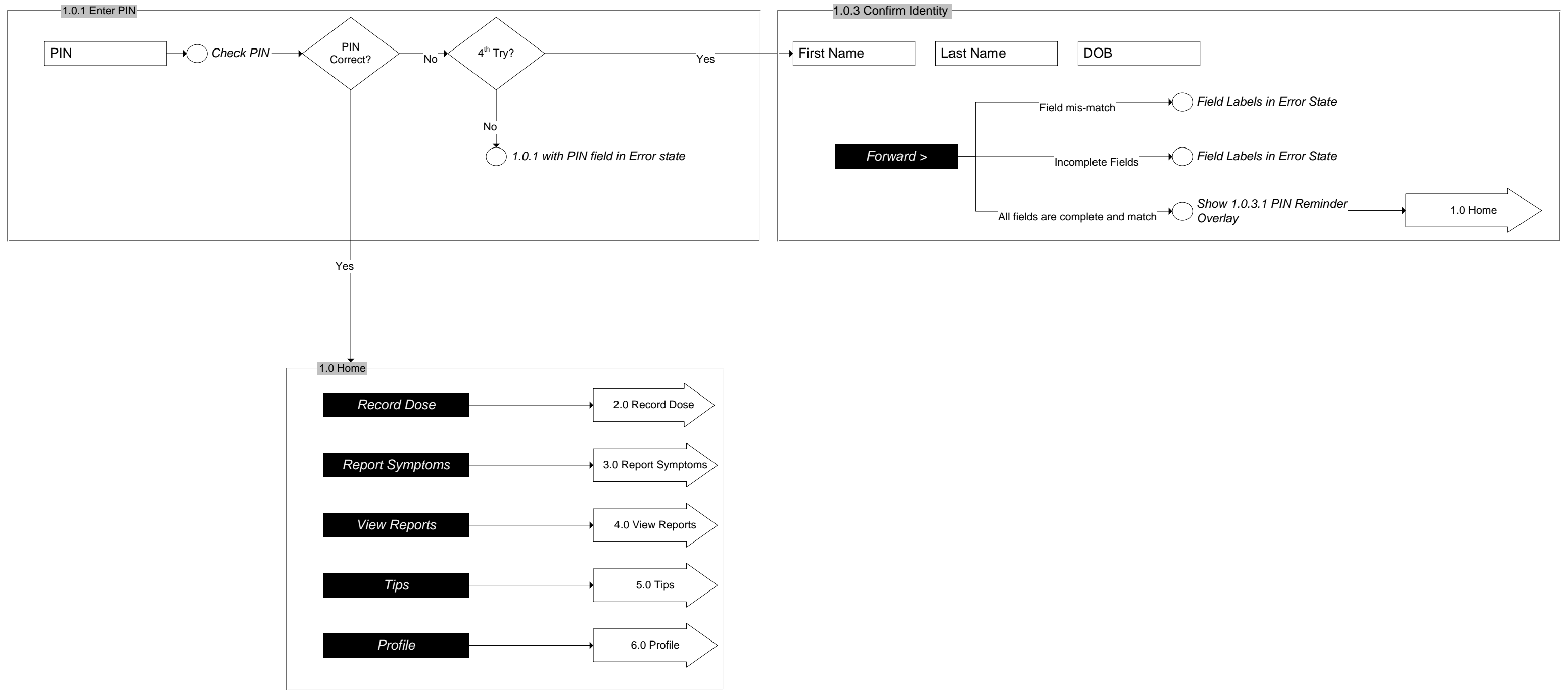

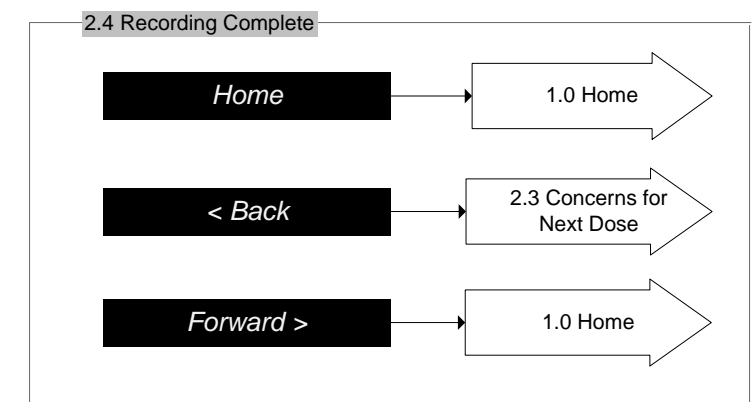
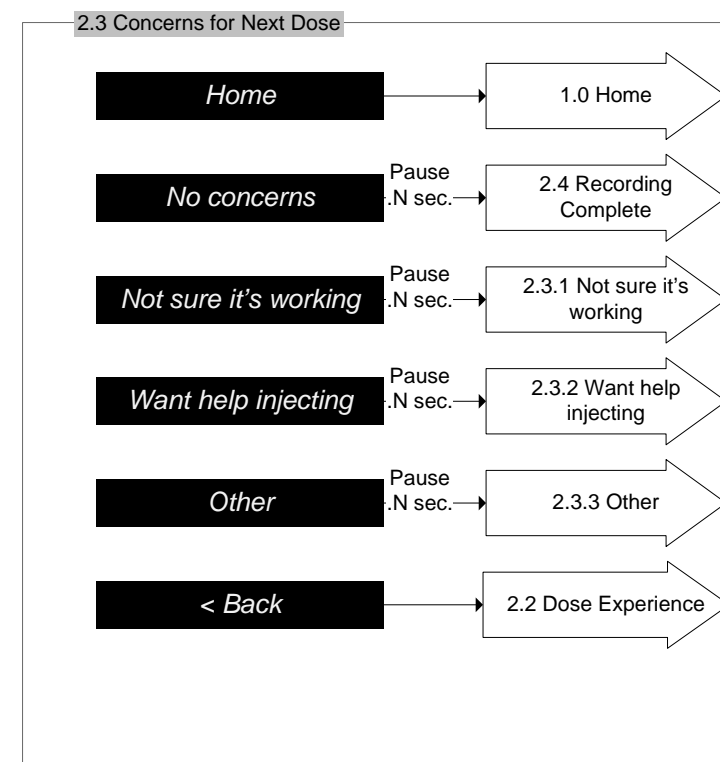
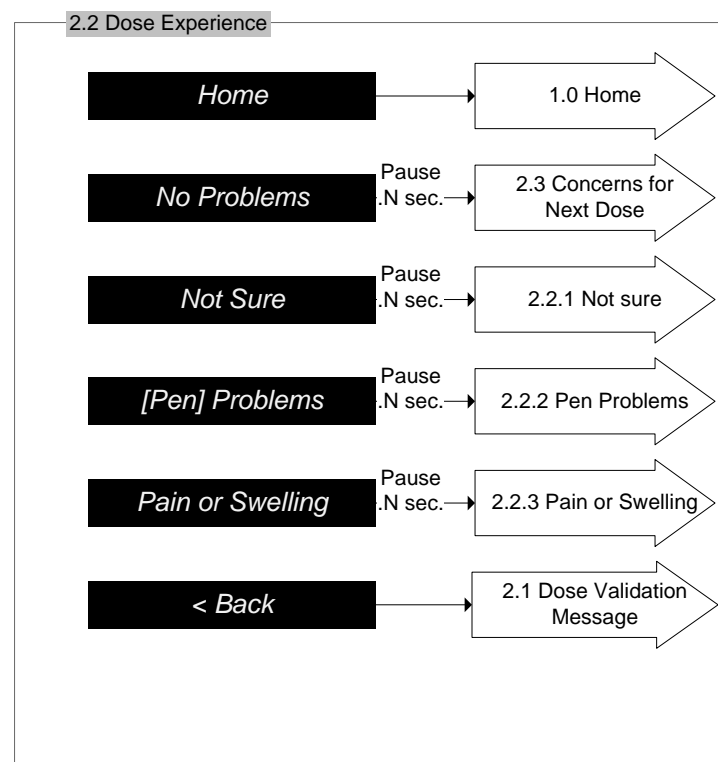
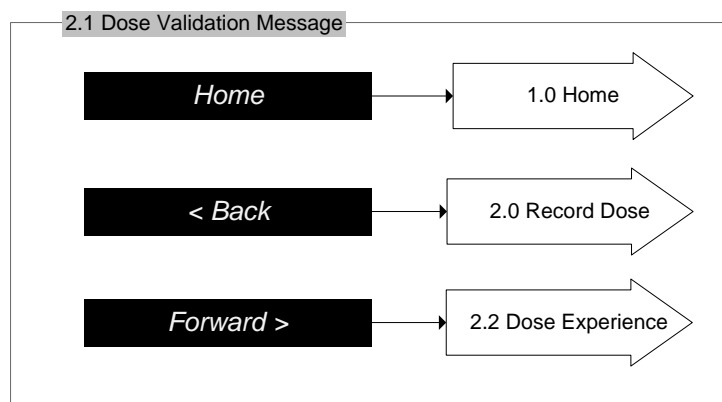
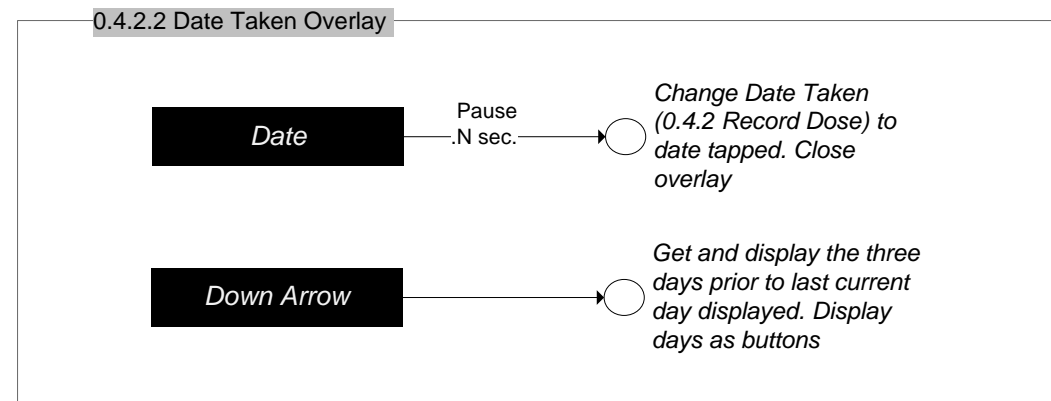
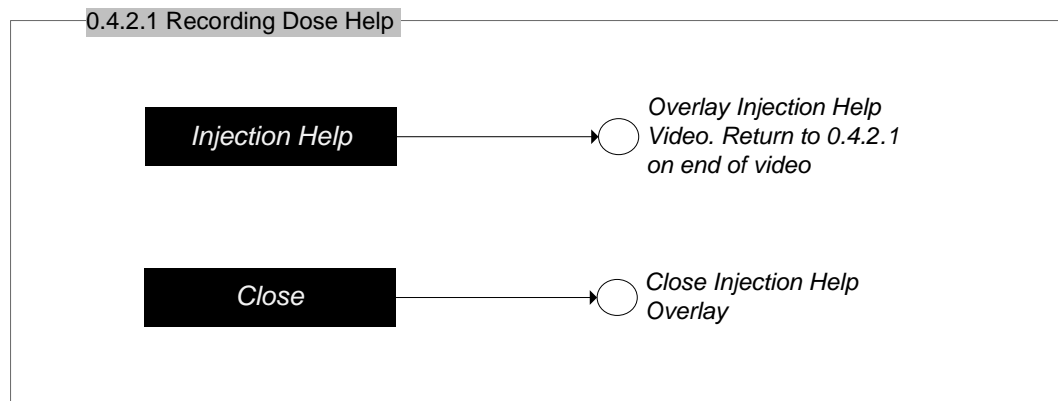
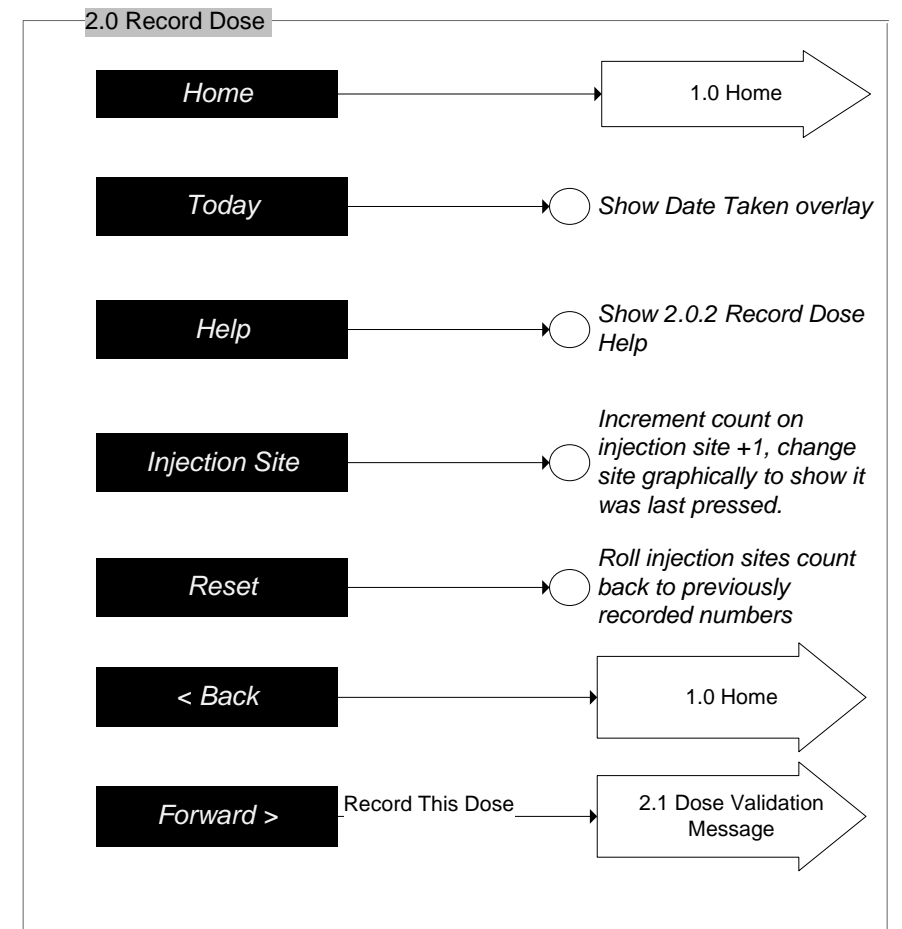
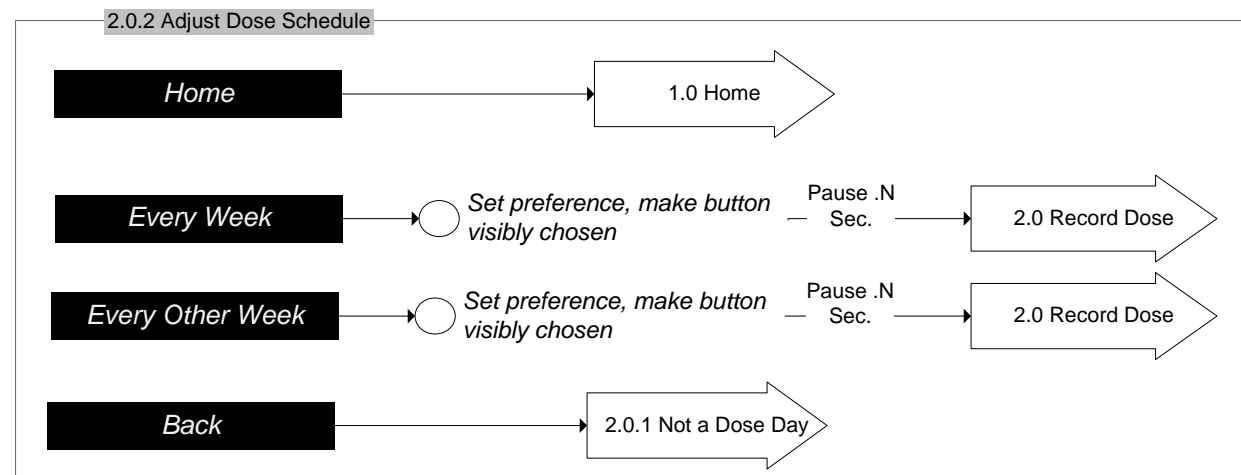
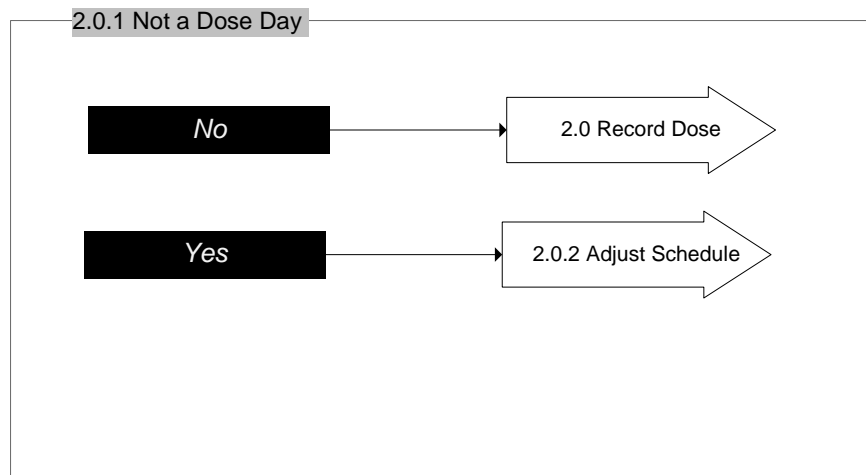

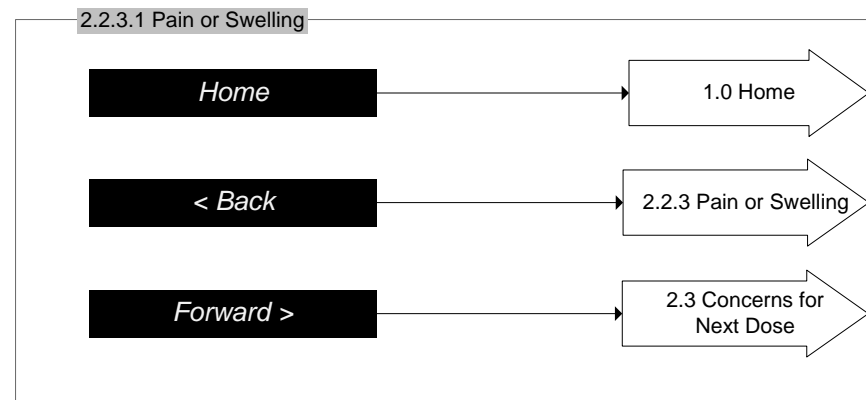
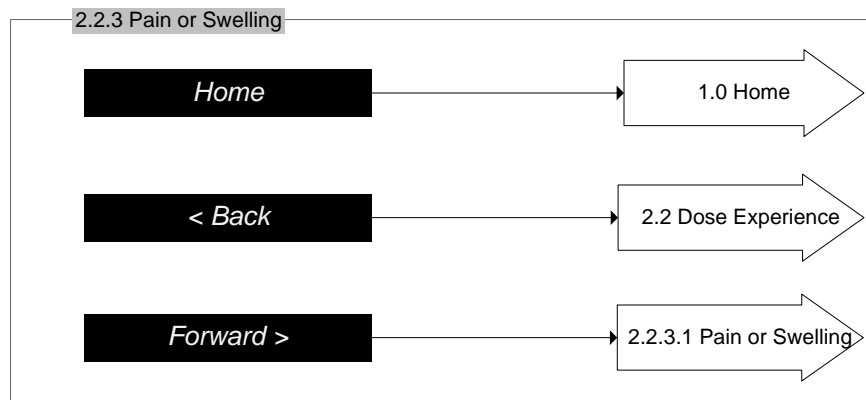
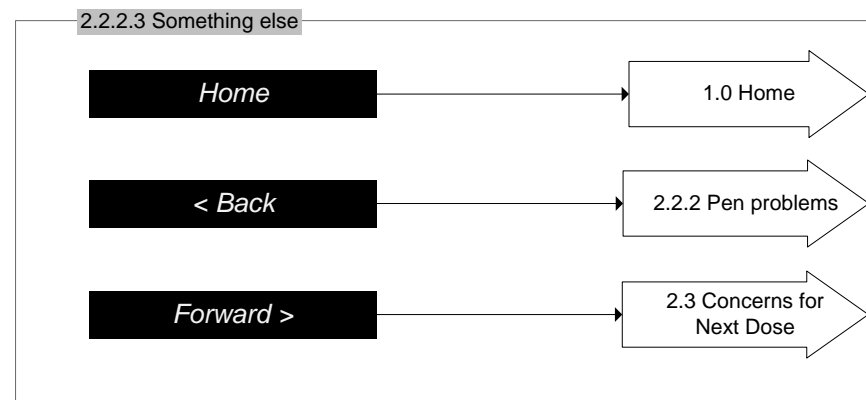
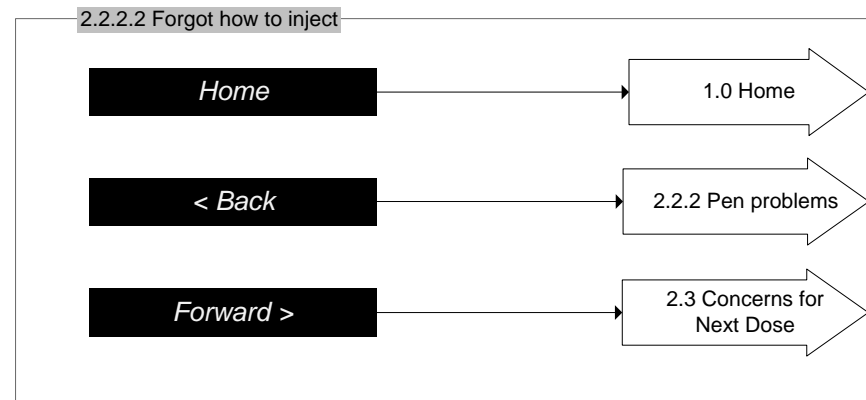
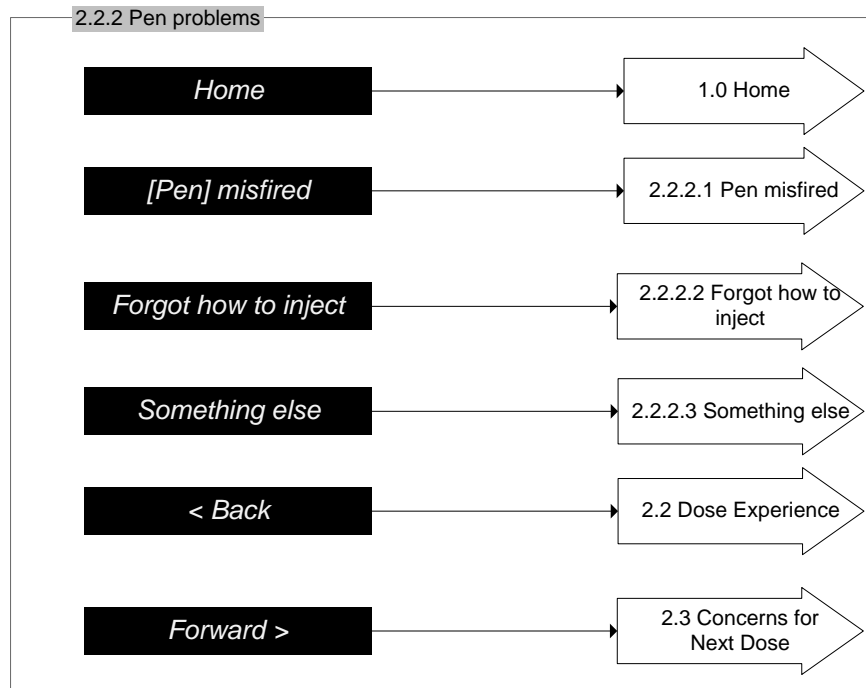
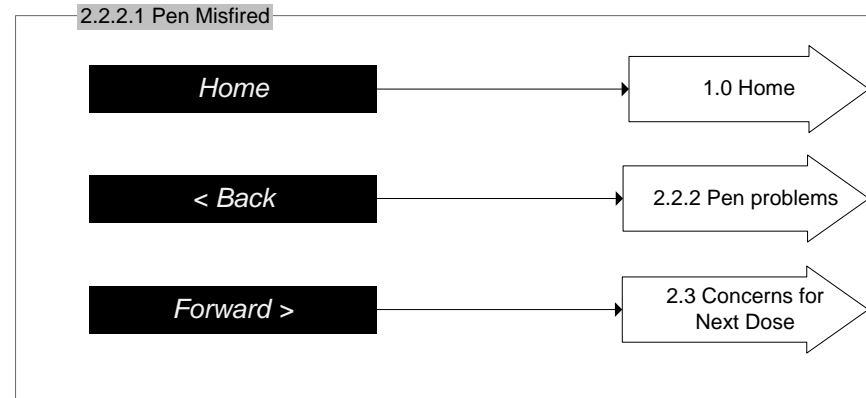
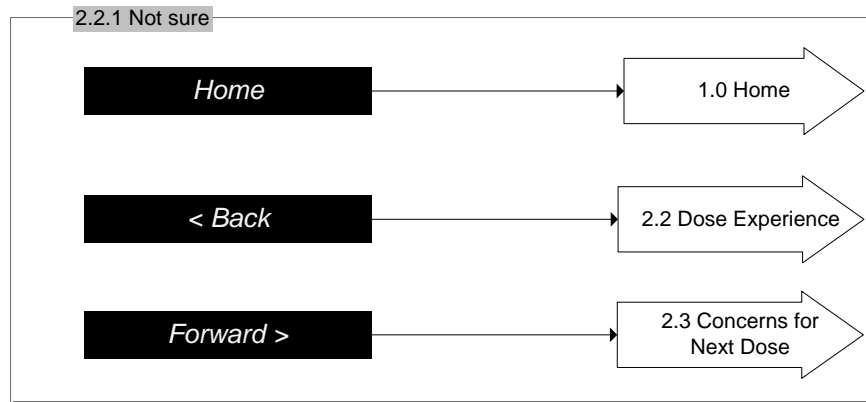

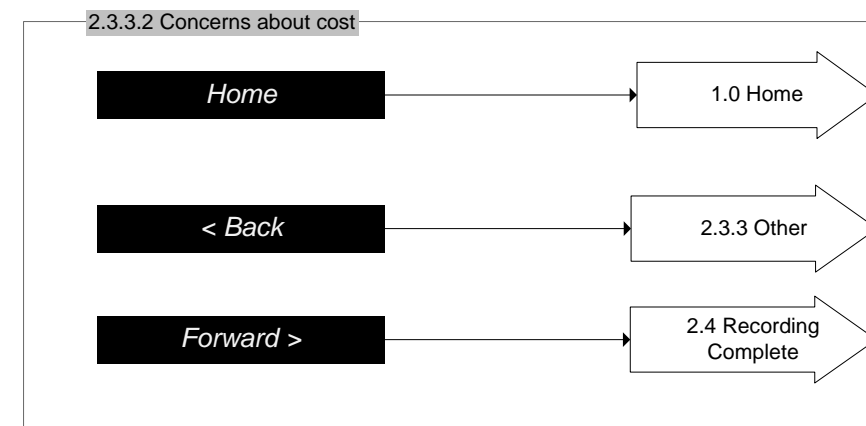
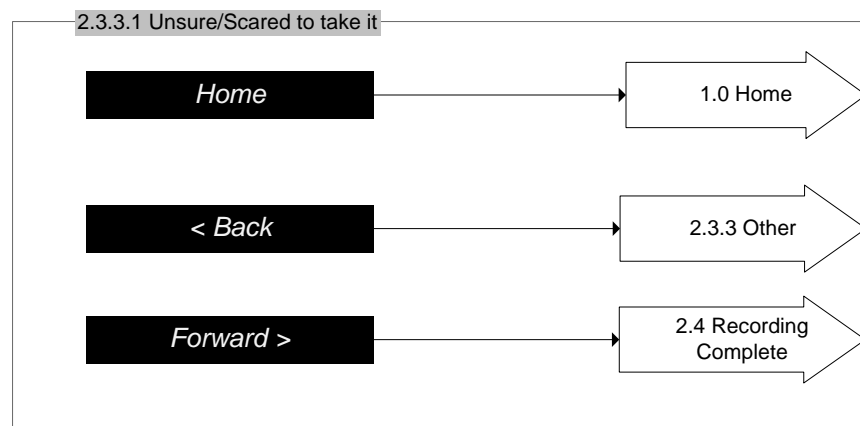
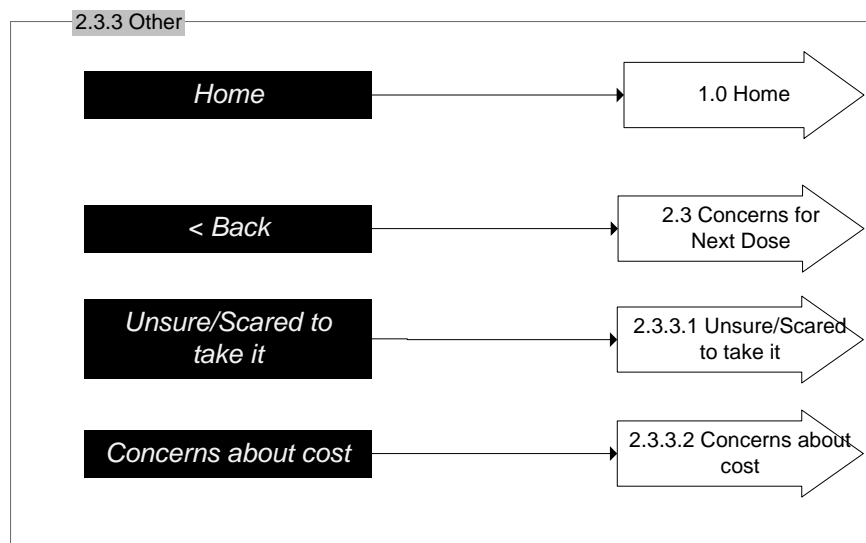
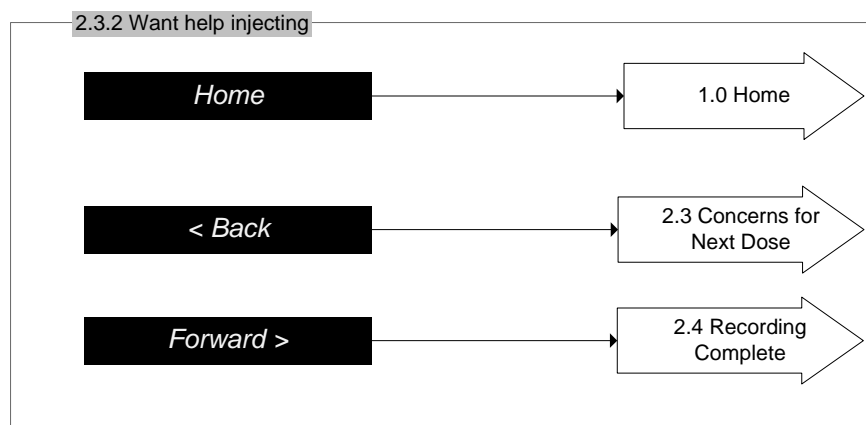
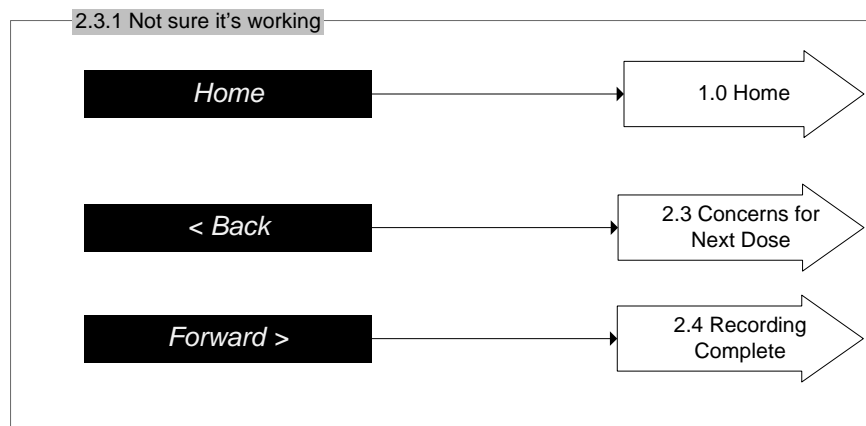

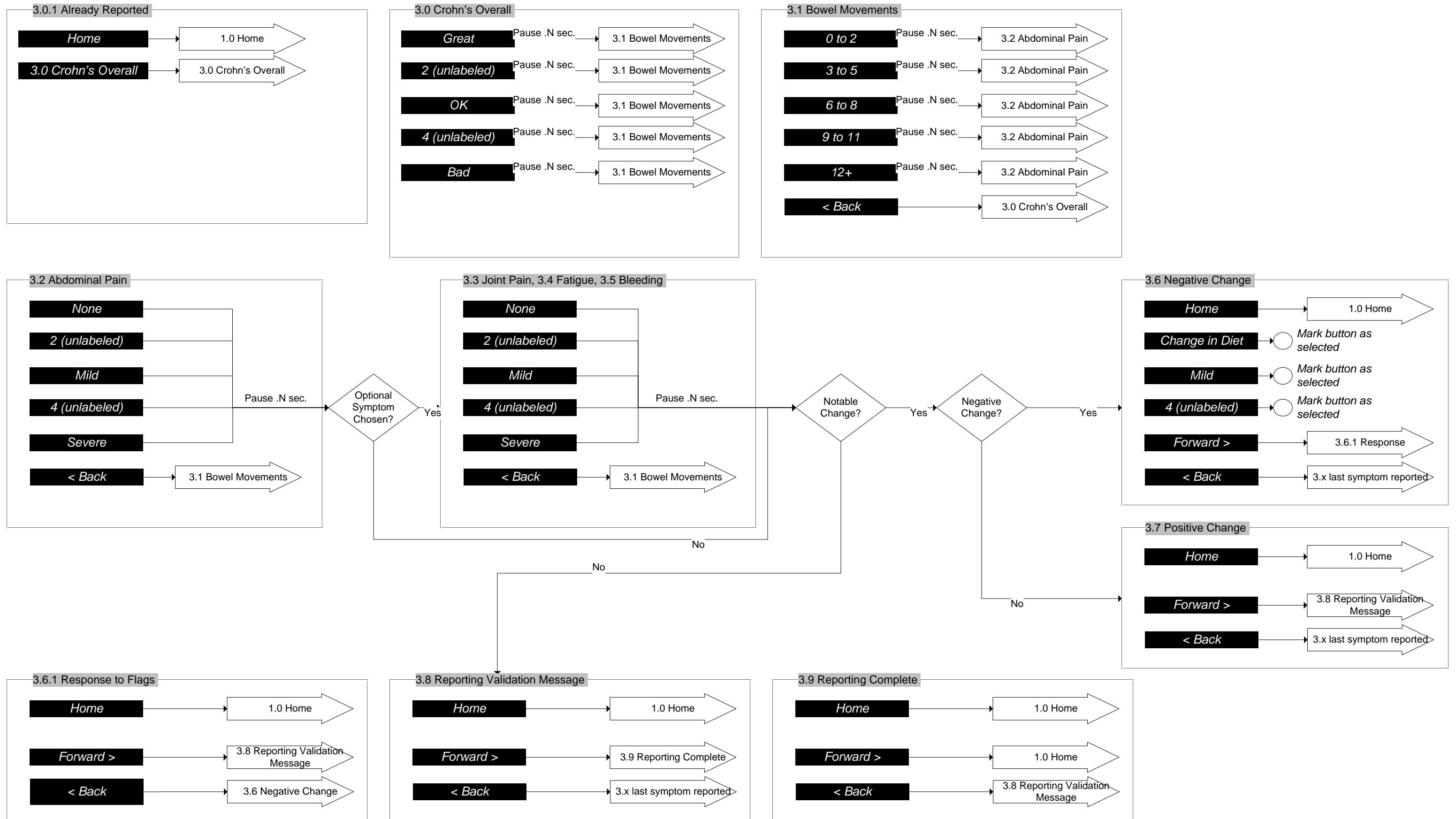

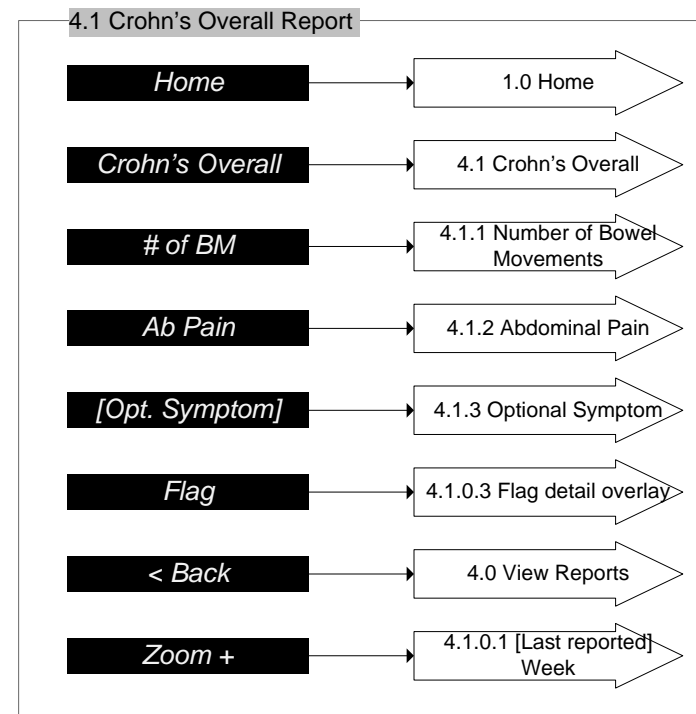
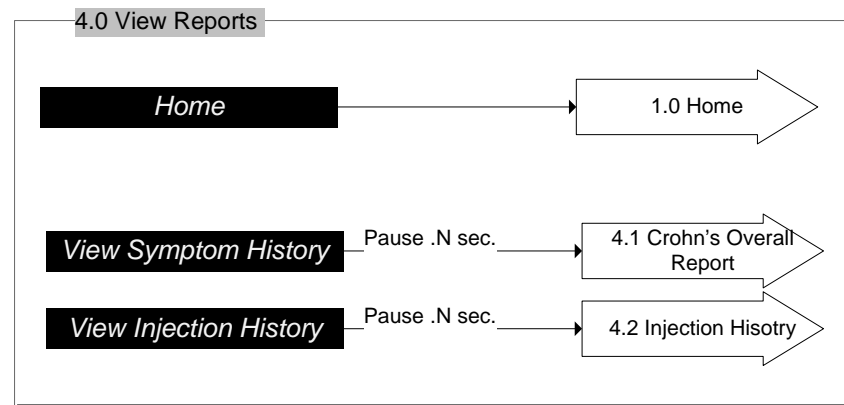

4.1.1 Number of Bowel Movements, 4.1.2 Abdominal Pain, and 4.1.3 Optional Symptom are identical in functionality to 4.1 Crohn's Overall.

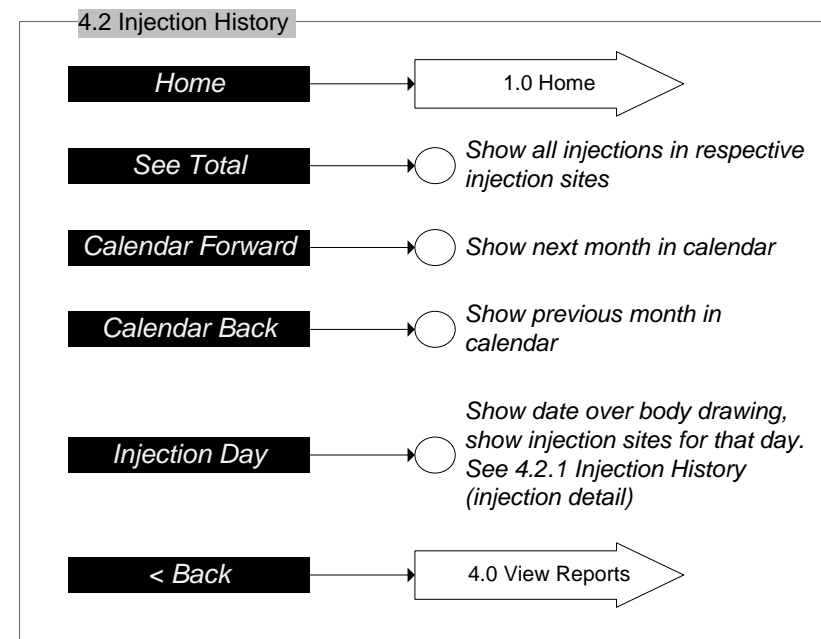
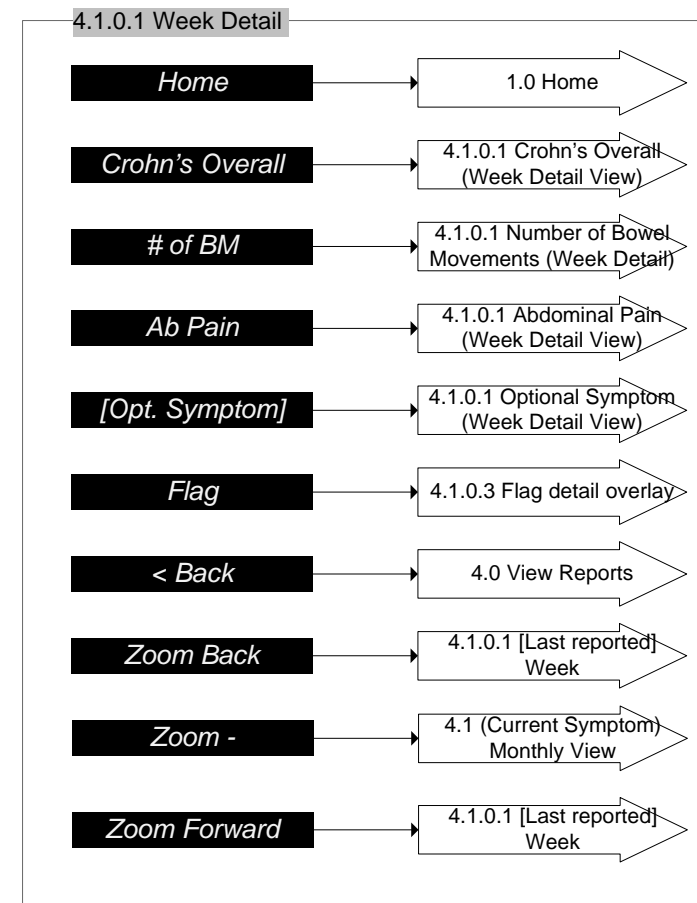

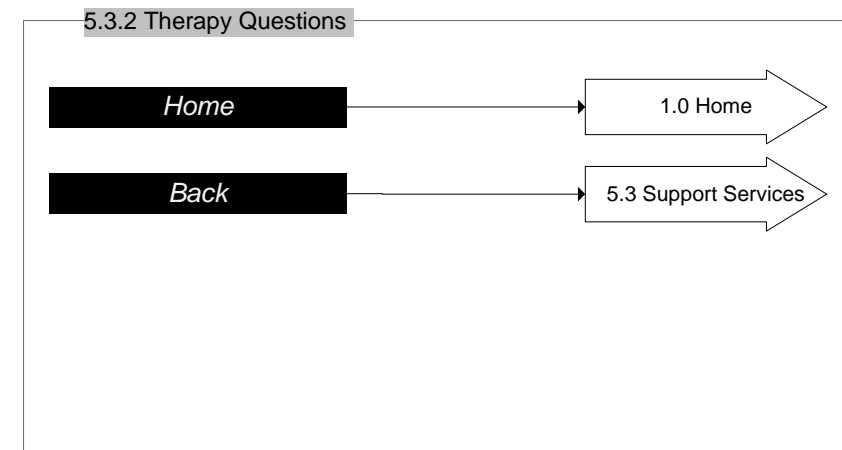
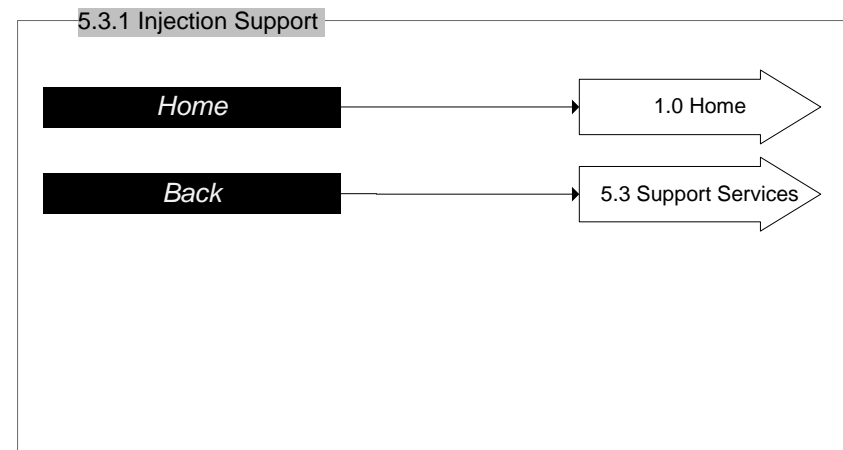
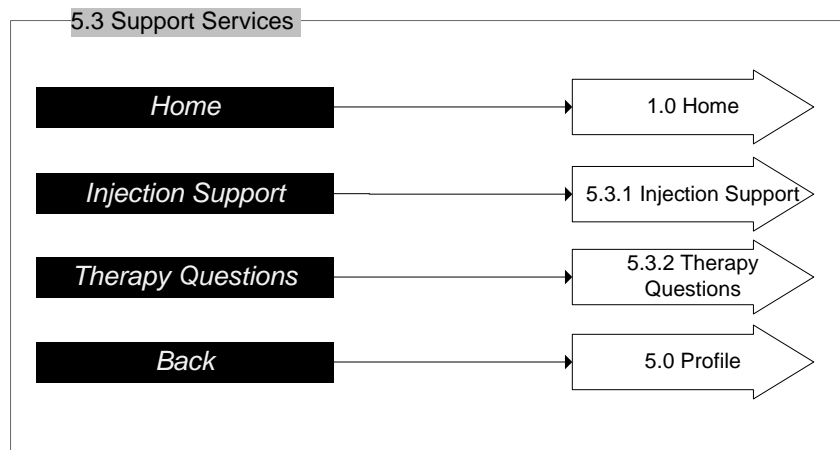
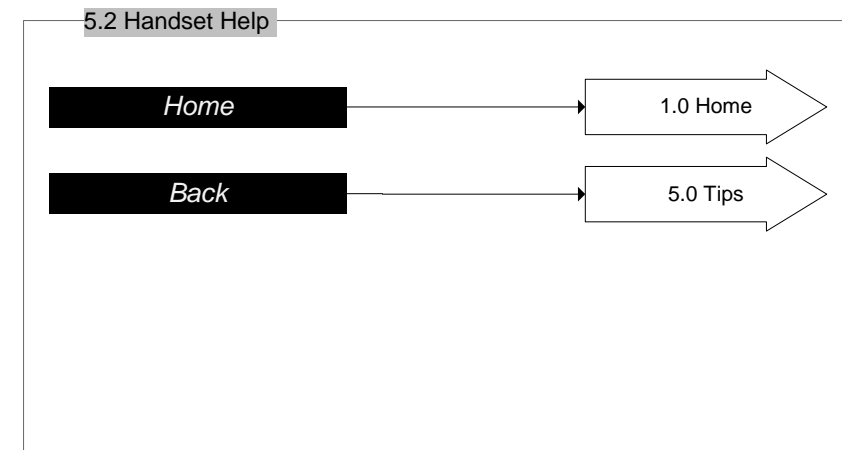
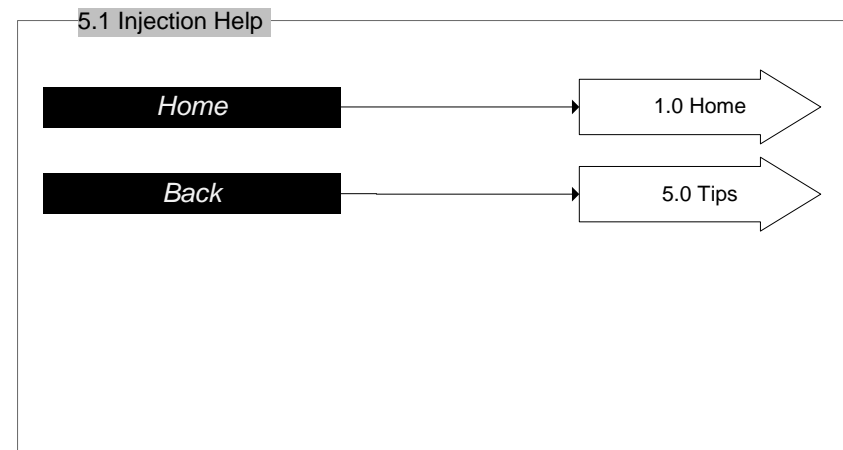
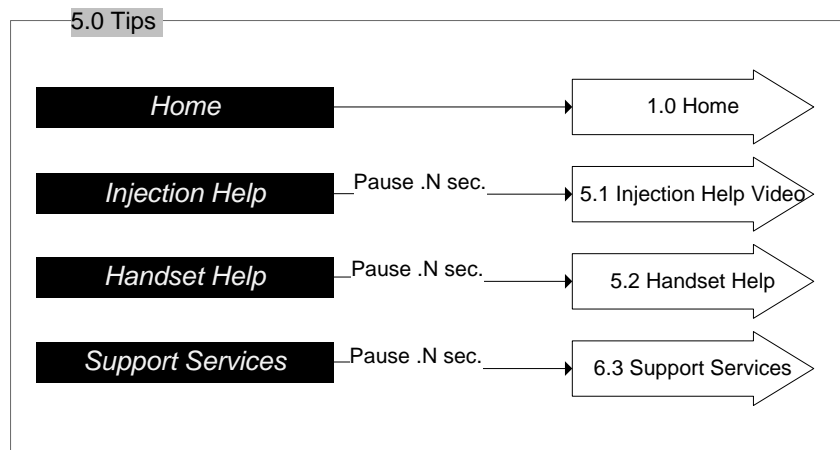

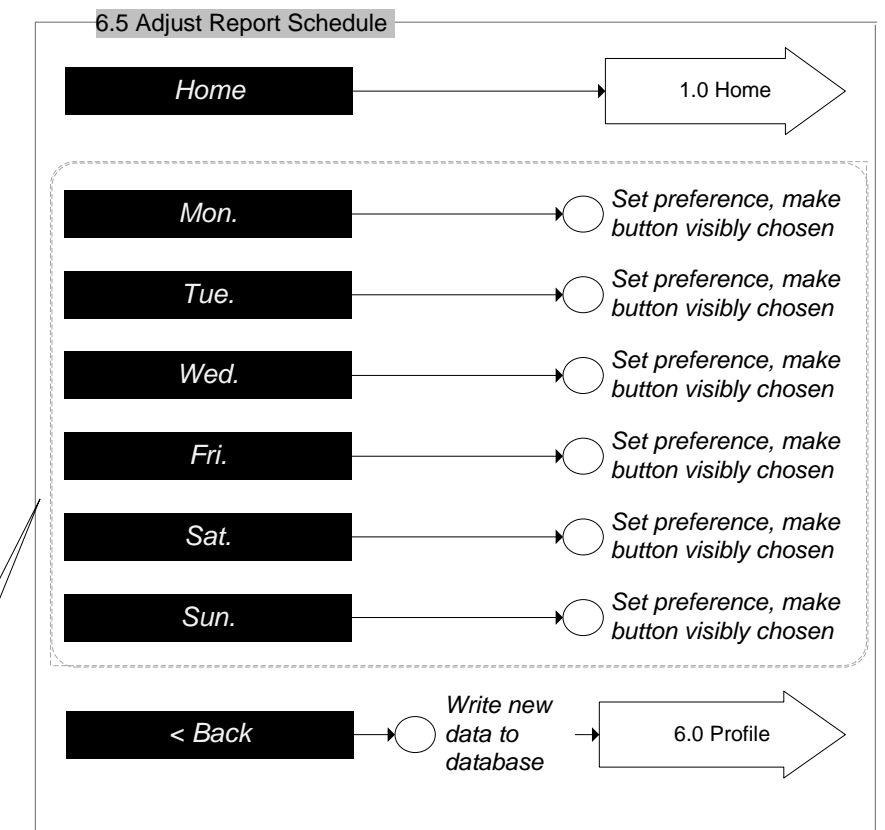
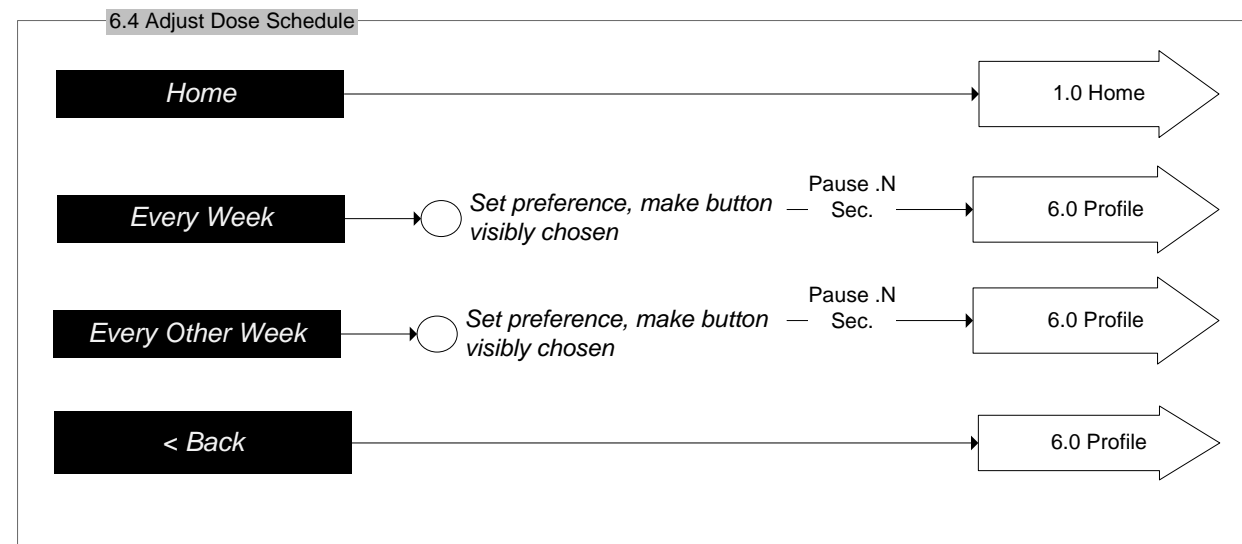
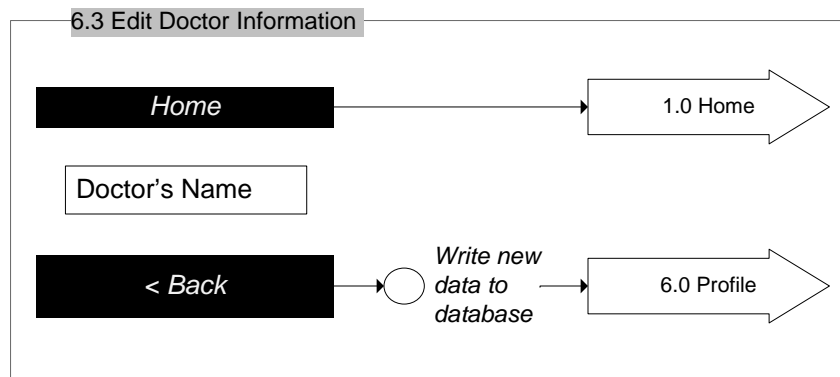
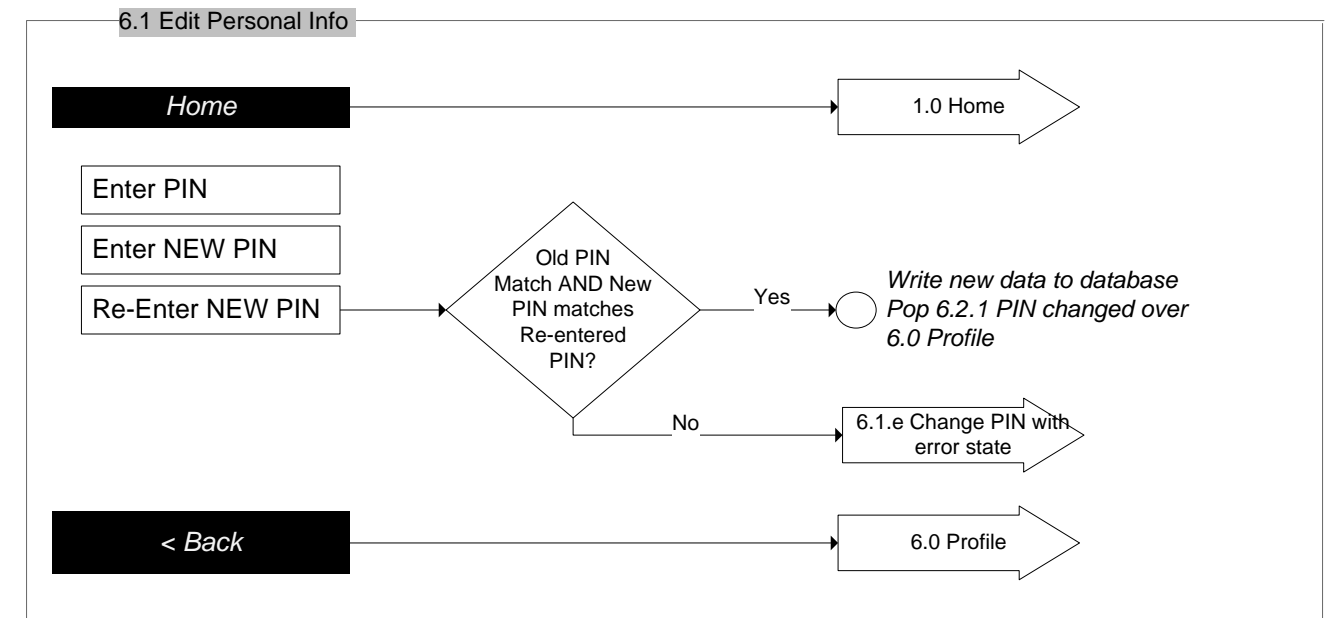
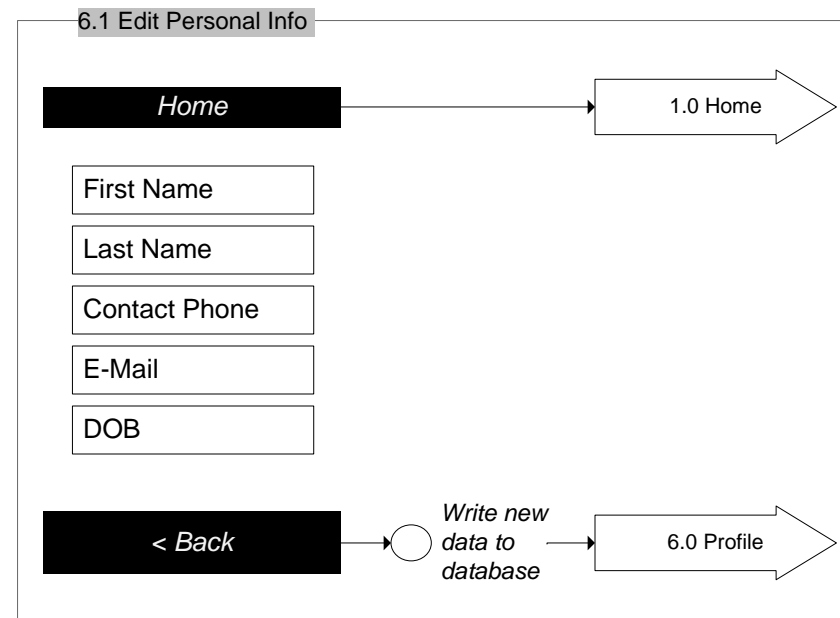
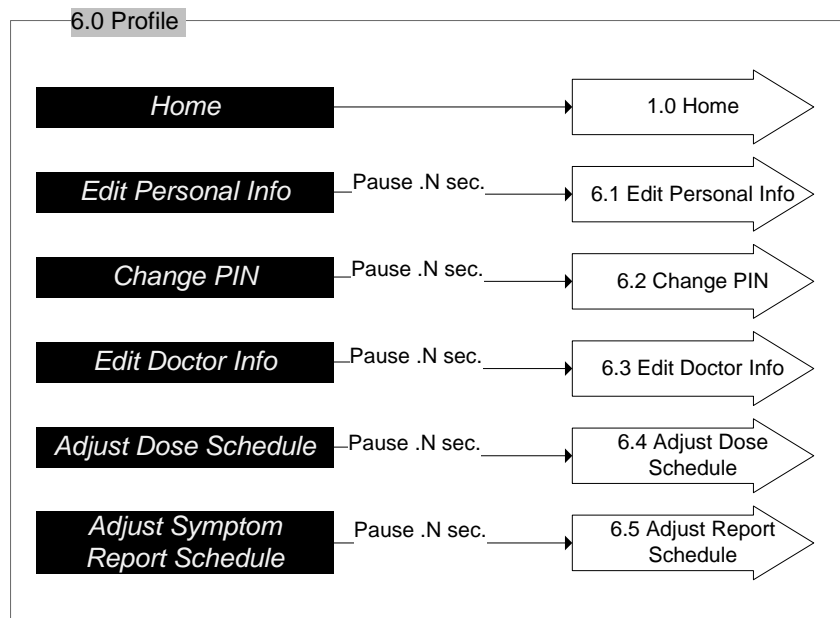

Note the 6 potential report days are the 6 days of the week NOT chosen as the dose day.

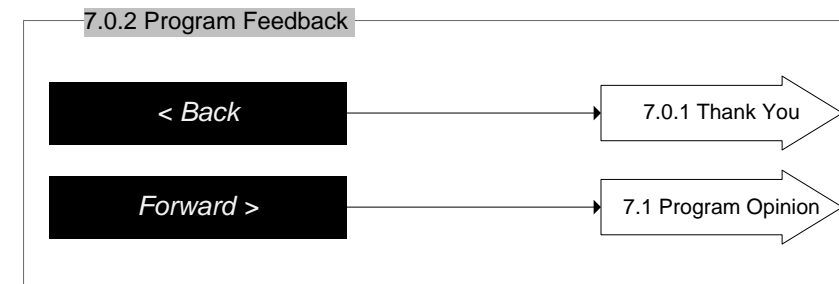
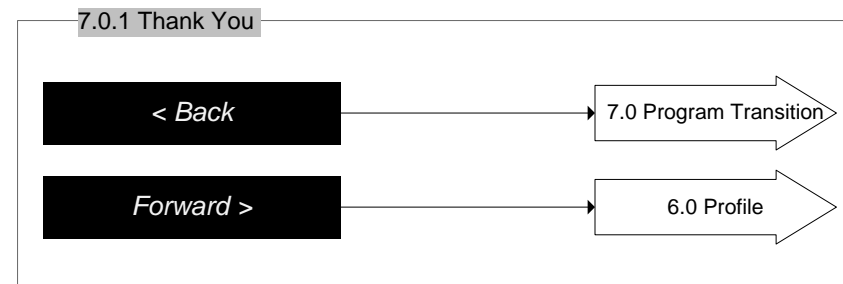
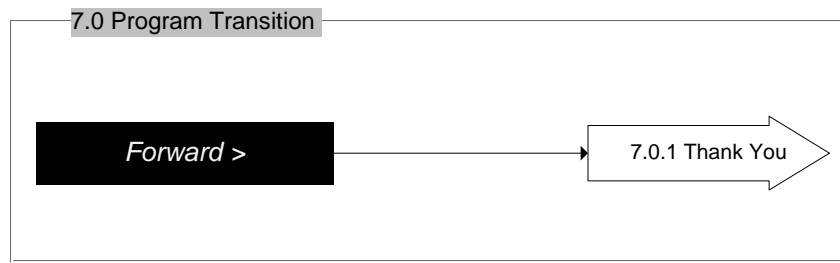

Note the 6 potential report days are the 6 days of the week NOT chosen as the dose day.

